



Hon. Steven Guilbeault  
Minister of Environment and Climate Change  
House of Commons  
Parliament Buildings  
Ottawa, ON K1A 0H6

March 31, 2023

Sent via email [ec.ministre-minister.ec@canada.ca](mailto:ec.ministre-minister.ec@canada.ca)

**Re: Request for Designation for ARC-100 Small Modular Reactor Project**

---

Dear Minister Guilbeault,

We are writing on behalf of Sierra Club Canada Foundation, We the Nuclear Free North, Protect Our Waterways – No Nuclear Waste, and the Coalition of Responsible Energy Development in New Brunswick (CRED-NB) to request that the proposed ARC-100 Small Modular Nuclear Reactor (SMR) demonstration project at Point Lepreau, New Brunswick (the “project”) be designated for a federal impact assessment pursuant to section 9(1) of the *Impact Assessment Act* (“IAA”).

As the project has not substantially begun, and nor has another federal authority exercised a power or function that could permit the project to be carried out, in whole or in part, you are not prohibited from designating this project for an IA pursuant to subsection 9(1) of the Act.

In contrast to the previous designation request submitted in July 2022 for this project, which focused on the two proposed nuclear reactors for New Brunswick (the “first request”), this request is to bring to your specific attention, new information and new issues about NB Power’s proposed ARC-100 nuclear reactor, which have arisen since the first request.

We submit this request to designate the project for an impact assessment and request a new decision from the Impact Assessment Agency of Canada (the “Agency”) and yourself, as Minister of Environment and Climate Change, based on the following:

1. There have been material changes to the project since the first request was submitted such that adverse effects in areas of federal jurisdiction, that the Agency previously concluded would be mitigated by other legislative mechanisms, are no longer valid.

Among the material changes are plans for the ARC-100 to reprocess its spent fuel to extract plutonium using pyroprocessing technology. This was not mentioned by the proponent NB Power and therefore not considered in the review of the first request. This material change may also trigger an IA pursuant to the *Physical Activities Regulations* under the *IAA*;

2. The Agency made significant errors of fact and law in its analysis about the project upon which the Minister of Environment and Climate Change relied, regarding adverse effects, the treatment of the project's fuel waste, and constitutionally protected Indigenous rights;
3. In light of the material changes to the project, the decision rejecting the first designation request for the project (the "December 2022 Decision") is now out of date and incorrect, as it fails to consider a number of significant adverse effects in areas of federal jurisdiction, including changes to the environment in another province and outside of Canada;
4. The December 2022 Decision failed to have regard to core purposes of the *IAA*, including the promotion of cooperation and coordination among provincial and federal governments, the application of the precautionary principle, the fostering of sustainability, and commitments to meaningful public participation.

Sierra Club Canada Foundation, Protect our Waterways and We the Nuclear Free North join CRED-NB in making this request given their direct interest in the impacts of the ARC-100 SMR project and their knowledge relevant to the project within their areas of interest. Our joint request comes as a response to new information that has come to light since the filing of the first request, since it is evident that effects beyond the province of New Brunswick will occur.

**Sierra Club Canada Foundation (SCCF)** is a members-based national non-profit charitable foundation with a core mission to empower people to be leaders in protecting, restoring and enjoying healthy and safe ecosystems. SCCF is a national leader in engagement on nuclear energy issues through its work to champion climate solutions and a rapid transition to clean energy. As a national environmental non-profit organization, SCCF has contributed to including nuclear energy issues in reports by the national Green Budget coalition, has produced dozens of news and blog posts about nuclear energy on its website, and most recently has hosted several national webinars on Energy Democracy including the role of nuclear energy in Canada's energy transition.

**We the Nuclear Free North (WTNFN, the Alliance)** is a northern Ontario alliance comprised of Indigenous and non-Indigenous individuals and organizations. It was formed in 2020, in response to a site in Kenora District being shortlisted by the Nuclear Waste Management Organization (NWMO) as one of two potential sites for a radioactive waste facility that would receive all of Canada's existing high level nuclear fuel waste. There is a high level of concern among residents in northern Ontario about the anticipated and potential adverse impacts of this project, including the potential for radio-contaminants to air, ground and surface

waters during transportation and the operation of the processing plant and deep geological repository (DGR), as well as the potential for longer-term and catastrophic releases during transportation, operations or from the DGR in the event of an accident.

**Protect our Waterways** is a concerned group of citizens in South Bruce, Ontario united in a common cause to prevent the establishment of a highlevel radioactive storage facility in our community known as a Deep Geological Repository (DGR). Our community is one of two sites designated by the NWMO for a DGR. Protect Our Waterways is composed of a wide cross section of South Bruce citizens, from farmers and rural land owners to residents within the villages of Teeswater, Mildmay, Formosa, Belmore, Carlsruhe and Deemerton in Ontario.

**CRED-NB** is a community-based organization, advocating for responsible, renewable, nuclear-free energy development to address the climate crisis. CRED-NB comprises more than 20 citizen groups and businesses and more than 130 individuals across New Brunswick. Since forming in May 2020, CRED-NB has expressed concern and shared information with the public about the health, safety, environmental, cultural and financial impacts of nuclear power. CRED-NB was also involved in a designation request for this project submitted in July 2022.

It is also our view that public concern for this project merits its designation for an IA, in keeping with subsection 9(1) of the *IAA* that sets out on the basis of public concern alone, designation can be warranted. Since the first request was submitted to the Minister in July 2022, public concern has grown significantly about the ARC-100 project. The high public interest value precipitated the Legislative Assembly of New Brunswick Standing Committee holding a two-day hearing on SMRs in early 2023. CBC radio and CBC online, Global TV and other national media outlets have increased their coverage of the topic as well, in response to the high public interest in SMRs.

We therefore respectfully ask that you consider our new designation request. We also ask that the IAAC's regional office in Ontario in addition to Atlantic Canada review our request; three of the four requesting groups are active in Ontario, and significant impacts are posed beyond the province where the project is physically located.

Sincerely,



Gretchen Fitzgerald, Sierra Club Canada Foundation

On behalf of:

Brennain Lloyd, We the Nuclear Free North

Bill Noll, Protect Our Waterways

Susan O'Donnell, Coalition for Responsible Energy Development in New Brunswick

cc

Impact Assessment Agency of Canada

Commissioner of the Environment and Sustainable Development, Jerry DeMarco

*Members of Parliament*

Minister of Crown-Indigenous Relations, Marc Miller

Minister of Health, Jean-Yves Duclos

Minister of Natural Resources, Jonathan Wilkinson

Minister of Finance, Chrystia Freeland

Minister of Innovation, Science and Economic Development, François-Philippe Champagne

Minister of Foreign Affairs, Mélanie Joly

Minister of Intergovernmental Affairs, Infrastructure and Communities, Dominic Leblanc

Minister Responsible for the Atlantic Canada Opportunities Agency, Ginette Petitpas Taylor

Leader of the Conservative Party of Canada, Pierre Pollièvre

Leader of the New Democratic Party of Canada, Jagmeet Singh

Leader of the Bloc Québécois, Yves-François Blanchet

Leader of the Green Party of Canada, Elizabeth May

*Members of Parliament in Ontario*

Eric Melillo, MP, Kenora

Hon. Patty Hajdu, MP, Thunder Bay Superior

Ben Lobb, MP, Huron—Bruce

Brian Masse, MP, Windsor West

*Member of Parliament in New Brunswick*

John Williamson, MP, New Brunswick Southwest

*Member of Provincial Parliament in Ontario*

Minister of Agriculture, Food and Rural Affairs, Lisa Thompson

*Member of the New Brunswick Legislature*

Andrea Anderson-Mason, MLA, Fundy-The Isles-Saint John West

**REQUEST FOR DESIGNATION OF A PHYSICAL ACTIVITY UNDER  
SECTION 9 OF THE *IMPACT ASSESSMENT ACT***

**ARC-100 Small Modular Reactor Project, New Brunswick**

March 31, 2023

**Prepared by:**

Kerrie Blaise, JD MSc  
Susan O'Donnell, PhD

**Submitted by:**

Sierra Club Canada Foundation  
PO Box 2007 STN B Ottawa ON K1P 5W3  
613-241-4611 • 1-888-810-4204

[info@sierraclub.ca](mailto:info@sierraclub.ca)

<https://www.sierraclub.ca/>

## CONTENTS

<b>I.</b>	<b>BACKGROUND &amp; MATERIAL CHANGE IN PROJECT</b>	<b>1</b>
1.0	The First Designation Request	1
2.0	Material Changes in the Project	2
3.0	Revised Project Description	10
4.0	No Limitation on Making a New Decision	11
<b>II.</b>	<b>ERRORS OF LAW AND FACT IN THE AGENCY'S ANALYSIS ON THE FIRST REQUEST</b>	<b>11</b>
1.0	Nuclear Licensing pursuant to the <i>Nuclear Safety and Control Act</i>	12
2.0	Provincial Environmental Impact Assessment	14
3.0	Nuclear Waste Oversight pursuant to the <i>Nuclear Fuel Waste Act</i>	16
4.0	Fostering Reconciliation and the Protection of Indigenous Rights	20
5.0	Serious and irreversible risks from ARC-100 Fuel	22
6.0	Mischaracterization of ARC-100 reactor design state of development	23
<b>III.</b>	<b>UNADDRESSED ADVERSE EFFECTS TO AREAS OF CORE FEDERAL JURISDICTION</b>	<b>24</b>
1.0	A change to the environment in another province	24
2.0	A change to the environment outside of Canada	25
<b>IV.</b>	<b>GRANTING THE DESIGNATION ALIGNS WITH THE PURPOSES OF THE /AA</b>	<b>28</b>
1.0	Promoting cooperation between federal and provincial governments	28
2.0	Adherence to the precautionary principle	30
3.0	Fostering sustainability	32
4.0	Meaningful public participation	32
<b>V.</b>	<b>PUBLIC CONCERN ALONE MERITS DESIGNATION OF THE PROJECT</b>	<b>34</b>
<b>VI.</b>	<b>CONCLUSION</b>	<b>36</b>
	<b>APPENDIX A – Access to Information Release</b>	
	<b>APPENDIX B – ARC Clean Energy Presentation</b>	

## I. BACKGROUND & MATERIAL CHANGE IN PROJECT

### 1.0 The First Designation Request

On July 4, 2022, the Coalition for Responsible Energy Development in New Brunswick (CRED-NB) requested that the federal Minister of Environment and Climate Change designate two small modular nuclear reactor (SMR) projects proposed by Énergie NB Power (“NB Power” or the “proponent”) for impact assessment (the “first request”).<sup>1</sup> This request included letters of support from 13 environmental and public interest groups across Canada and two Indigenous groups, the Passamaquoddy Recognition Group representing the Peskotomuhkati Nation at Skutik, and the Wolastoq Grand Council. In the following weeks, many other letters of support requesting a designation for the project followed to the Minister of Environment and Climate Change (“Minister”), including from two environmental groups in New Brunswick and one Indigenous organization representing nine Mi’gmaq First Nation communities in New Brunswick. Hundreds of individuals also sent letters supporting the request for an IA.

The first request sought designation for the project on the basis that:

- The project relied on novel technologies and activities
- No alternate or equivalent legislative mechanism existed to publicly examine accidents and malfunctions, cumulative effects, alternatives to the project, economic feasibility, principles of intergenerational equity, and risks due to weapons proliferation
- The project posed adverse effects within areas of core federal jurisdiction
- The public had demonstrated significant concern about the project

On December 22, 2022, the Minister released his decision, choosing not to designate the project.<sup>2</sup> This decision was based on analysis from the Impact Assessment Agency of Canada (“Agency Analysis”)<sup>3</sup> that recommended the project not be designated on the basis that:

- The legislative processes that currently applied to the project and related consultations with potentially impacted Indigenous peoples provided a sufficient framework to address potential adverse effects and impacts
- The project must be carried out in compliance with federal and provincial legislation, including the federal *Nuclear Safety and Control Act*; the *Fisheries Act*; the *Species at Risk Act*; the *Migratory Birds Convention Act, 1994*; the *Canadian Navigable Waters Act*; and the *Canadian Environmental Protection Act, 1999*; and the provincial *Clean Environment Act* and the *Clean Water Act*

---

<sup>1</sup> CRED-NB, “Request for Designation of Project” (4 July 2022), online: <https://iaac-aeic.gc.ca/050/evaluations/document/145163> [First Request]

<sup>2</sup> IAAC, “Minister’s Response – Small Modular Reactor Demonstration Project” (22 December 2022), online: <https://iaac-aeic.gc.ca/050/evaluations/document/145836?culture=en-CA> [Minister’s Response]

<sup>3</sup> IAAC, “Analysis Report - Whether to Designate the Small Modular Reactor Demonstration Project in New Brunswick pursuant to the *Impact Assessment Act*,” (December 2022) online: <https://iaac-aeic.gc.ca/050/evaluations/document/145835?culture=en-CA> [Agency Report]

## 2.0 Material Changes in the Project

The requesters submit there is a new basis for designation because of material changes in circumstances regarding the scope of the project since the first designation request was submitted. This new information results from the disclosure of information not previously known nor accessible in the public domain, and thus a basis to revisit the Agency's analysis and the Minister's resulting decision.<sup>4</sup>

As a result of this new information, the Agency's assessment of the project is no longer valid as it is based on an under-inclusive description of the project that fails to account for many of the direct activities associated with the project. As a result, there are new effects within federal jurisdiction, as well as adverse direct or incidental effects, that require the first request and recommendation of the Agency and decision of the Minister issued on December 22, 2022 to be reconsidered in full, alongside this new designation request.<sup>5</sup>

In the first request, CRED-NB described the project as a small modular nuclear reactor (SMR) demonstration project at the Point Lepreau nuclear site, in the Bay of Fundy region of New Brunswick where NB Power proposed to site, construct and operate two nuclear reactor designs, including the one by Advanced Reactor Concepts, a 100 MWe (286 MWth) ARC-100 SMR ("ARC SMR").<sup>6</sup> The purpose of the project was understood as a demonstration project for electricity generation.<sup>7</sup>

This framing of the project was based on publicly available information supplied by the proponent and the SMR vendor,<sup>8</sup> and closely echoed the project description provided in the Agency's Analysis:

The Proponent is proposing the construction, operation, and decommissioning of an ARC-100 SMR commercial demonstration unit at the existing Point Lepreau Nuclear Generating Station, at Point Lepreau, New Brunswick along the Bay of Fundy [...] The expected operating life of the Project would be approximately 60 years, and the Proponent is currently planning for interim onsite storage of three core loads of used fuel. Upon final shutdown, and as part of decommissioning, the Proponent anticipates that spent fuel would be transported to a deep geological repository for long-term management.<sup>9</sup>

---

<sup>4</sup> IAAC, "Operational Guide: Designating a Project under the Impact Assessment Act," (19 May 2022) online: <https://www.canada.ca/en/impact-assessment-agency/services/policy-guidance/designating-project-impact-assessment-act.html>

<sup>5</sup> IAA, s 9(1)

<sup>6</sup> First Request, p 2

<sup>7</sup> First Request, p 2 and 4

<sup>8</sup> First Request, p 2 citing Énergie NB Power, "What's happening in New Brunswick," online: <https://smrnb.ca/whats-happening-in-newbrunswick/>; ARC Clean Energy, "The ARC-100 Advanced Small Modular Reactor," online: <https://www.arcenergy.co/technology>

<sup>9</sup> Agency Report, p 4



The Agency similarly framed the purpose of the project as being a commercial demonstration unit to provide electrical output.<sup>10</sup>

According to information obtained through Access to Information (ATI) legislation, released on January 3, 2023,<sup>11</sup> it became apparent that the proponent, NB Power, was also proposing numerous other related activities, infrastructure, permanent and temporary structures and physical works directly associated with the construction, operation and decommissioning of the ARC-100 project. It also became evident that the purpose of the project was not limited to electricity generation in the province of New Brunswick.

Four significant changes to the project that were not otherwise known or in the public domain, arose because of the Access to Information request (enclosed at **Appendix A**). A fifth significant change came to light from a report published in November 2022 by the U.S. Academy of Sciences, Engineering and Medicine in Washington (enclosed at **Appendix B**).

As a result, the proposed project now includes the following activities and aims (each detailed below):

1. Formation of a centralized fleet support centre for the deployment of ARC SMRs elsewhere in New Brunswick, Canada and International markets;
2. Use of ARC SMR for production of hydrogen for international markets;
3. Construction, oversight and decommissioning of a new storage facility for radioactive fuel waste;
4. Construction of new marine works outside the licensed boundaries of an existing nuclear site boundaries; and,
5. Intention by the SMR vendor, ARC Clean Energy, to reprocess the ARC-100 used fuel waste.

As these details were not publicly known prior to the submission of the first request, these undertakings and their potential impacts on areas of federal jurisdiction did not form the basis of the request provided by CRED-NB nor the record from which hundreds of groups and individuals voiced concerns about the project's effects.

This new request is submitted jointly by the following groups as it is evident, based on information released since the filing of the first request, that effects beyond the province of New Brunswick will occur:

**Sierra Club Canada Foundation (SCCF)** is a members-based national non-profit charitable foundation with a core mission to empower people to be leaders in protecting, restoring and enjoying healthy and safe ecosystems. SCCF is a national leader in engagement on nuclear energy issues through its work to champion climate solutions and a rapid transition to clean

---

<sup>10</sup> Agency Report, p 64

<sup>11</sup> IAAC, Access to Information, File No. A-2022-00045 /CS (3 January 2023) [ATI], **Appendix A**

energy. As a national environmental non-profit organization, SCCF has contributed to including nuclear energy issues in reports by the national Green Budget coalition, has produced dozens of news and blog posts about nuclear energy on its website, and most recently has hosted several national webinars on Energy Democracy including the role of nuclear energy in Canada's energy transition.

**We the Nuclear Free North** is a northern Ontario alliance comprised of Indigenous and non-Indigenous individuals and organizations. It was formed in 2020, in response to a site in Kenora District being shortlisted by the Nuclear Waste Management Organization (NWMO) as one of two potential sites for a radioactive waste facility that would receive all of Canada's existing and future high level nuclear fuel waste. There is a high level of concern among residents in northern Ontario about the anticipated and potential adverse impacts of this project, including the potential for radio-contaminants to air, ground and surface waters during transportation and the operation of the processing plant and deep geological repository (DGR), as well as the potential for longer-term and catastrophic releases during transportation, operations or from the DGR in the event of an accident.

We the Nuclear Free North includes in its alliance the organizations Environment North and Northwatch who have knowledge and experience related to various proposals for deep geological repositories and past and current investigations related to a potential site for a deep geological repository dating back several decades.

**Protect our Waterways** is a concerned group of citizens in South Bruce, Ontario united in a common cause to prevent the establishment of a high level radioactive storage facility in our community known as a Deep Geological Repository (DGR). Our community is one of two sites designated by the NWMO for a DGR. Protect Our Waterways is composed of a wide cross section of South Bruce citizens, from farmers and rural land owners to residents within the villages of Teeswater, Mildmay, Formosa, Belmore, Carlsruhe and Deemerton in Ontario.

**The Coalition for Responsible Energy Development in New Brunswick (CRED-NB)** is a community-based organization, advocating for responsible, renewable, nuclear-free energy development to address the climate crisis. CRED-NB comprises more than 20 citizen groups and businesses and more than 130 individuals across New Brunswick. Since forming in May 2020, CRED-NB has expressed concern and shared information with the public about the health, safety, environmental, cultural and financial impacts of nuclear power. CRED-NB was also involved in a designation request for this project submitted in July 2022.

1. *Formation of a centralized fleet support centre for the deployment of ARC SMRs elsewhere in New Brunswick, Canada and International markets*

On November 28, 2022, the Port of Belledune in northern New Brunswick announced the signing of a Memorandum of Understanding (MOU) with ARC Clean Energy and Cross River Infrastructure Partners

“to generate a minimum of 1GW of zero-emission firm heat and power for industrial users at the port’s recently announced Green Energy Hub.”<sup>12</sup>

Information obtained through ATI suggests that this plan to site ARC-100 reactors at the Port of Belledune is part of a wider plan by NB Power to site a “centralized fleet support centre in New Brunswick.”<sup>13</sup> According to NB Power, a fleet approach is part of its ARC-100 commercial demonstration project (see **Figure 1** below for NB Power’s 4-phased summary of the project, which references a “fleet approach” as part of Phase 4).

As defined in the interprovincial Ontario, New Brunswick, Saskatchewan and Alberta *Strategic plan for the deployment of small modular reactors*, a fleet approach means “deploying the same technology in multiple jurisdictions.”<sup>14</sup> This interprovincial agreement from March 2022 noted “NB Power and ARC Clean Energy will discuss the formation of central fleet services” (emphasis added) to permit the deployment of ARC SMRs elsewhere in NB, Canada and for export.<sup>15</sup> Apart from the reference ‘to discuss’ the proposal, there was no other information in the public domain at the time of the first request indicating that a commercial fleet approach was an active part of the proposed SMR project at Point Lepreau.

**Figure 1.** NB Power’s ARC-100 Commercial Demonstration<sup>16</sup>

COMPLETE	IN PROGRESS		
Phase 1	Phase 2	Phase 3	Phase 4
<ul style="list-style-type: none"> <li>▪ Project Development &amp; Execution Planning               <ul style="list-style-type: none"> <li>» Cost &amp; Schedule</li> </ul> </li> <li>▪ Establish Strategic Partners</li> <li>▪ Conceptual Design</li> </ul>	<ul style="list-style-type: none"> <li>▪ Canadian Nuclear Safety Commission (CNSC)               <ul style="list-style-type: none"> <li>» Phase 2 Ready; Fall 2021</li> </ul> </li> <li>▪ Preliminary Design Validation of Cost Estimates &amp; Integrated Schedule</li> <li>▪ Scoping Fuel Supply &amp; Manufacturing Capabilities</li> </ul>	<ul style="list-style-type: none"> <li>▪ Complete Detailed Engineering/Constructability Procurement Orders (Supply Chain)</li> <li>▪ Licensing &amp; Approval for Construction Permit Issued Site Prep-Work Begins</li> <li>▪ Execute Construction Contract</li> </ul>	<ul style="list-style-type: none"> <li>▪ Construction of ARC-100 Unit</li> <li>▪ Test &amp; Commissioning</li> <li>▪ <b><u>Commercial Operations Fleet Approach</u></b> [emphasis added]</li> </ul>

<sup>12</sup> Port of Belledune, “Belledune Port authority to pursue an ARC Clean Technology aSMR project with Cross River Infrastructure Partners at planned Green Energy Hub,” (28 November 2022) online: <https://portbelledune.ca/belledune-port-authority-to-pursue-an-arc-clean-technology-asmr-project-with-cross-river-infrastructure-partners-at-planned-green-energy-hub/> [Port of Belledune]

<sup>13</sup> ATI, p 35

<sup>14</sup> Ontario, “A strategic plan for the deployment of small modular reactors” (2 March 2022), online: <https://www.ontario.ca/page/strategic-plan-deployment-small-modular-reactors> [Strategic Plan]

<sup>15</sup> Strategic Plan

<sup>16</sup> ATI, p 37

Based on more recent information obtained through ATI, it is evident that NB Power considers the fleet approach to be within the scope of the ARC demonstration project. Therefore, activities related to the formation of fleet services cannot be omitted from the scope of the undertaking and are central to the Minister's review of this designation request.

## 2. *Use of ARC SMR for production of hydrogen for international markets*

Following a country visit by the Chancellor of Germany in August 2022, Germany and Canada signed a joint declaration of intent establishing the Canada-Germany Hydrogen Alliance.<sup>17</sup> The Premiers of New Brunswick, Newfoundland and Labrador, Nova Scotia and Prince Edward Island also signed a statement supporting the proposed Canada-Germany Hydrogen Alliance, echoing the declaration's goals to establish a hydrogen market, share production technologies, and establish a hydrogen supply chain between Canada and Germany.<sup>18</sup> As the declaration reads:

The Participants aim to closely collaborate on all aspects necessary to kickstart the hydrogen economy and to create a transatlantic supply chain for hydrogen well before 2030, with first deliveries aiming for 2025.<sup>19</sup>

Information obtained through ATI revealed that the ARC reactor could be used for the production of hydrogen, as part of this newly formed alliance.<sup>20</sup> Meeting notes in the ATI release stated "NB Power also signed a deal with Germany for a hydrogen facility supplied potentially with ARC reactors" and an NB Power slide deck stated a nuclear hydrogen working group was formed in August 2021.<sup>21</sup> As previously noted, it was also announced on November 28, 2022, that the Port of Belledune had signed an MOU with ARC Clean Energy and Cross River Infrastructure Partners for a project that "would see the development of an ARC-100 unit to serve as an energy source for expanded hydrogen production and other industries based at the Port."<sup>22</sup>

The use of the ARC reactor to potentially provide hydrogen to oversee markets in Germany is directly related to the purpose of the project and cannot be omitted from the scope of the undertaking and the Minister's review of this designation request.

---

<sup>17</sup> Prime Minister of Canada, "Prime Minister concludes a successful visit by German Chancellor Olaf Scholz," (23 August 2022), online: <https://pm.gc.ca/en/news/news-releases/2022/08/23/prime-minister-concludes-successful-visit-german-chancellor-olaf>

<sup>18</sup> Euractiv, "Germany's Scholz visits Canada to build 'reliable network' " (21 August 2022), online:

<https://www.euractiv.com/section/energy/news/germanys-scholz-visits-canada-to-build-reliable-network/>

<sup>19</sup> Government of Canada, "Joint declaration of intent between the Government of Canada and the Government of the Federal Republic of Germany on establishing a Canada-Germany Hydrogen Alliance," online: <https://natural-resources.canada.ca/climate-change-adapting-impacts-and-reducing-emissions/canadas-green-future/the-hydrogen-strategy/joint-declaration-intent-between-the-government-canada-and-the-government-the-federal/24607>

<sup>20</sup> ATI, p 32, 26

<sup>21</sup> ATI, p 32

<sup>22</sup> Port of Belledune

### 3. *Construction, oversight and decommissioning of a new storage facility for radioactive fuel waste*

Information obtained through ATI revealed that a new facility for onsite radioactive fuel waste storage would be necessary for the ARC-100 SMR project, as its fuel waste was not compatible with existing fuel storage methods for CANDU fuel from the Point Lepreau reactor. As set out in an email from NB Power to the Agency, “it should be noted that the fuel string [for the ARC-100] is much longer than a CANDU bundle, so the interim storage will be different than that used currently for the Lepreau used CANDU fuel.”<sup>23</sup>

While the first request raised concerns about the costs for managing the high-level radioactive waste generated by an SMR, noting that costs would be higher than waste from a CANDU reactor,<sup>24</sup> and referenced literature that SMR waste would be more voluminous and difficult to manage than the current fleet of CANDU reactors for which initial storage is in adjacent pools cooled by water,<sup>25</sup> it was not known at the time that the fuel waste would not be compatible with existing waste storage options on site at Point Lepreau, necessitating the construction of new facilities and ancillary infrastructure for its on-site storage.

The construction, oversight and decommissioning of a new storage facility for radioactive fuel waste is directly related to the undertaking of this project. It was not considered in the December 2022 Decision and cannot be omitted from the Minister’s review of this designation request.

### 4. *Construction of new marine works outside of a licensed nuclear site*

Information obtained through ATI revealed the potential for new marine works outside the licensed boundaries of the Point Lepreau nuclear site.<sup>26</sup> As further explained in the Agency’s Analysis of the project, the project may include “a water intake and outfall/discharge pipe to Indian Cove” and “two saltwater options” were being reviewed for feasibility.<sup>27</sup>

While concerns about impacts to the Bay of Fundy were raised in the first request and figured prominently in submissions received by civil society groups and Indigenous nations,<sup>28</sup> it was not known that new marine works would need to be constructed, such as to trigger the need for *Canadian Navigable Waters Act* approval from Transport Canada.<sup>29</sup>

---

<sup>23</sup> ATI, p 199

<sup>24</sup> First Request, p 25

<sup>25</sup> First Request, p 27 citing Krall, L. M., Macfarlane, A. M., & Ewing, R. C. “Nuclear waste from small modular reactors” (2022) Proceedings of the National Academy of Sciences, 119(23), e2111833119

<sup>26</sup> ATI, p 178

<sup>27</sup> Agency Report, p 6, 16

<sup>28</sup> First Request, p 10, 17, 18, 19, 28, 65, 73, 74, 75

<sup>29</sup> Agency Report, p 6; *Canadian Navigable Waters Act*, RSC 1985, c N-22

This new information, including details about the aquatic infrastructure, must be provided by the proponent and considered by the Agency and Minister, and included within the project description of this designation request.

5. *The intention of ARC Clean Energy to reprocess the ARC-100 used fuel waste*

New information about the ARC-100 SMR has come to light, unknown at the time of the first designation request, indicating the intention for the ARC-100 to recycle its fuel. This new information, as detailed below, for the ARC-100 to be a breeder reactor and to reprocess its used fuel at Point Lepreau raises significant concerns for several reasons:

- Reprocessing used fuel – which involves extracting plutonium – is currently not permitted in Canada because of concerns of nuclear weapons proliferation; Canada has had an informal ban on reprocessing since the 1970s,<sup>30</sup> following India's testing of its first nuclear weapon made using plutonium from a "peaceful" nuclear reactor, a gift from Canada;
- Canadians have expressed strong opposition to plutonium reprocessing in this country. As part of the ongoing review of Canada's radioactive waste policy, more than 7,000 Canadians submitted letters including a demand that the policy bans reprocessing;<sup>31</sup> and
- The fact that the intent to reprocess the ARC-100 used fuel was not mentioned by the proponent, NB Power, in the Agency's first review raises an additional concern about the proponent's awareness of the true intent of the project and / or the veracity of the information they are sharing with the public. We have serious concerns about NB Power's lack of full disclosure of information.

There new information setting out NB Power's intention for the ARC-100 SMR to reprocess its fuel is as follows:

*First*, in a slide deck prepared by NB Power dated March 30, 2023, it notes the ARC-100 will have a "20 year fueling cycle & can recycle its used fuel" (emphasis added).<sup>32</sup> No further detail is provided, but we submit it is critical that the Agency inquire into the volume of reprocessing, as it may trigger an IA by

---

<sup>30</sup> See report from the Nuclear Waste Management Organization, "Status of Nuclear Fuel Reprocessing, Partitioning and Transmutation," (November 2003), online:

[https://www.nwmo.ca/~media/Site/Files/PDFs/2015/11/09/12/54/656\\_6-4StatusofNuclearFuelReprocessingPartitioningandTransmutation.ashx?la=en](https://www.nwmo.ca/~media/Site/Files/PDFs/2015/11/09/12/54/656_6-4StatusofNuclearFuelReprocessingPartitioningandTransmutation.ashx?la=en)

<sup>31</sup> In March 2022, the Council of Canadians conducted a letter-writing campaign regarding Canada's draft radioactive waste policy that resulted in 7,415 letters sent by Canadians across the country to the federal cabinet and other MPs. The letter included the following text: "The draft policy allows for consideration of extraction of fissile material such as plutonium and nuclear waste reprocessing without offering any more guidance than "due consideration" and respect for regulation. There is no technology that allows the safe reprocessing of radioactive waste and there is no reason to consider this activity in the future. The policy should simply forbid the practice."

<sup>32</sup> NB Power, "Advanced Small Modular Reactor Development in New Brunswick," [PowerPoint Presentation](#), (30 March 2023)

virtue of being captured under subsections 26(a) and/or 26(c) of the *Physical Project Regulations* (the "Project List").<sup>33</sup>

For instance, an IA would be required for this SMR if the reprocessing facility had a capacity of 100 t/year or more, or processed a quantity greater than  $10^{15}$  Bq per calendar year, of nuclear substances with a half-life greater than one year.<sup>34</sup> It was on this basis that the Agency found, in response to one of the two SMRs detailed in the first request for designation, that the Moltex SMR would require an IA. As the Agency stated, "the Moltex SMR would involve recycling spent fuel for use in the reactor, and would require construction and operation of a fuel reprocessing facility. The Proponent has indicated that the recycling of spent fuel and the new fuel reprocessing facility would likely be captured under subsections 26(a) and/or 26(c) of the Regulations."

Given that the volume of used fuel waste from the ARC-100 SMR planned for reprocessing is unknown, the Agency cannot determine if in fact the ARC-100 project, similar to the Moltex SMR, would be captured under subsections 26(a) and/or 26(c) of the Project List. We submit that, given the uncertainty, the project ought to be designated for an IA so that all the facts and intentions of the proponent can be fully reviewed and publicly queried.

*Second*, a November 2022 report issued by an expert panel with the U.S. Academy of Sciences, Engineering and Medicine in Washington (the "expert panel report") reveals the use of ARC-100 for pyroprocessing to recover plutonium and other transuranics to use as fresh fuel.<sup>35</sup> The U.S. expert panel report's comments about the ARC-100<sup>36</sup> are based on a presentation to the panel by senior ARC representatives in the U.S. in February 2021. The report and associated files related to the ARC presentation, bring to light significant departures from understandings about future uses of the SMR's radioactive fuel waste.

This new information about ARC's preferred long-term use of the ARC-100's used fuel also counters the Agency's understanding of the project, which in its Analysis report, set out that the ARC-100 design has a 20-year fuel cycle, with the intent to load the ARC-100 with a 20-year supply of fuel and to operate the reactor for 60 years, implying that the fuel would be loaded three times. This understanding is consistent with the information supplied by NB Power to the Agency, and February 2023 testimony to the Legislative Assembly of New Brunswick, where ARC representatives stated that the ARC-100 would use a 'once-through fuel cycle,' meaning that at the end of each fuel cycle, the used reactor fuel would

---

<sup>33</sup> *Physical Activities Regulations*, SOR/2019-285 [Project List]

<sup>34</sup> Project List, s 26(a) and 26(c)

<sup>35</sup> National Academies of Sciences, Engineering, and Medicine, "Merits and Viability of Different Nuclear Fuel Cycles and Technology Options and the Waste Aspects of Advanced Nuclear Reactors," (2022) Washington, DC: The National Academies Press. <https://doi.org/10.17226/26500>, online: <http://nap.nationalacademies.org/26500>

<sup>36</sup> ARC Clean Energy is the U.S.-based company (with an office in Saint John, New Brunswick) that intends to build its ARC-100 SMR design at Point Lepreau in New Brunswick, with NB Power being the proponent.

be stored in a temporary facility, with the intent to store it permanently in a deep geological repository, should one be built.<sup>37</sup>

However, findings of the expert panel's report released in November 2022, call this understanding into question. As the report reflects, two years prior, in a presentation by ARC in February 2021 to a committee of 16 nuclear experts with the U.S. National Academies in Washington, ARC representatives stated the *preferred* long-term ARC-100 fuel cycle is to use pyroprocessing to recover plutonium and other transuranics to use as fresh fuel.<sup>38</sup> ARC stated that the initial 20-year fuel irradiation cycle of the ARC-100 would provide ample time within which to develop a planning and development program for recycling its used fuel (see **Appendix B** for a detailed description of the reprocessing plans).

*Third*, it was confirmed in February 2023 during testimony to the Legislative Assembly of New Brunswick that the current intention of the ARC company is to operate the ARC-100 planned for Point Lepreau as a "breeder" reactor.<sup>39</sup> A breeder reactor breeds plutonium; it creates significantly more plutonium during fission than other types of reactors. A sodium fast reactor does not need to be a breeder. The only reason to make the SMR a breeder is to extract significant quantities of plutonium from the used fuel through reprocessing, for re-use as new fuel in a reactor. There is no reason for the ARC-100 to be a breeder unless the intent is to reprocess the spent fuel. This aligns with the intent of the historical reactor on which the ARC-100 design is based: the second Experimental Breeder Reactor (EBR-II), which operated in a research setting in the U.S.

The expert panel report also notes that due to the chemical reactivity of the sodium-bonded used fuel, that even for a once-through fuel cycle, reprocessing would be required to remove the sodium so as to avoid adverse chemical reactions or explosions which could compromise the integrity of any long-term storage system, including in underground caverns should it ever be placed in a deep geological repository as is currently being proposed by the nuclear industry.

### 3.0 Revised Project Description

Given the nature of the new evidence obtained through ATI and the recent expert panel report, the first request ought to be reconsidered in its entirety, and the prior analysis of the Agency and decision of the Minister reopened, and a review conducted of the evidence as a whole. While the information obtained

---

<sup>37</sup> Statement by William Labbe, ARC president and CEO, on Feb. 14, 2023, in testimony to the Legislative Assembly of New Brunswick Standing Committee on Climate Change and Environmental Stewardship.

<sup>38</sup> Statement by Dr. Ed Arthur, Vice-president for fuel cycle management and safeguards, ARC Clean Energy, on February 22, 2021 to the National Academies of Sciences, Engineering, and Medicine, Expert Committee on the Merits and Viability of Different Nuclear Fuel Cycles and Technology Options and the Waste Aspects of Advanced Nuclear Reactors, by video in Washington, D.C., Meeting archive at 3:54:40, see **Appendix B** for the full quotation and link to the video meeting archive

<sup>39</sup> Statement by William Labbe, ARC president and CEO, on Feb. 14, 2023, in testimony to the Legislative Assembly of New Brunswick Standing Committee on Climate Change and Environmental Stewardship, "We operate on a different spectrum, because we are a fast breeder reactor ...." <https://www.legnb.ca/en/webcasts/848> at 10:43 minutes.



through ATI was before the Agency and Minister, it was not, as discussed above, publicly available. Therefore, it would be procedurally unfair and prejudicial to members of the public, not to provide an opportunity to again request a designation for the project, seeking new analysis from Agency and a new decision from the Minister, taking into account the revised nature and purpose of the project.

The requesters submit that in light of the above information, the following revised project description more accurately reflects the suite of activities, projects and physical works proposed by the proponent and it ought to guide the review of this designation request:

The Proponent is proposing:

1. The construction, operation, and decommissioning of an ARC-100 SMR commercial demonstration unit for the purposes of on-grid electricity and hydrogen production for Germany;
2. A fleet support centre for ARC SMR deployment;
3. An onsite radioactive waste storage facility at the existing Point Lepreau Nuclear Generating Station, at Point Lepreau, New Brunswick along the Bay of Fundy;
4. New marine works outside of licensed nuclear site boundaries;
5. A reprocessing unit to extract plutonium from used nuclear fuel using pyroprocessing and to process the sodium-bonded used fuel to remove the chemically reactive materials before permanent storage; and
6. Eventual transportation through New Brunswick, Quebec and Ontario for processing and disposition to a deep geological repository in Ontario, should one be built.

#### **4.0 No Limitation on Making a New Decision**

The requesters submit that the Minister is not precluded from designating the project under subsection 9(7) of the *IAA*. The project has not substantially begun and nor has a federal authority exercised a power or performed a duty or function that would permit the project to be carried out, in whole or in part. Thus, the Minister is not prohibited from designating this project for an IA pursuant to subsection 9(1) of the Act.

## **II. ERRORS OF LAW AND FACT IN THE AGENCY'S ANALYSIS ON THE FIRST REQUEST**

In response to the first request, the Agency prepared a report and recommendation to the Minister noting existing legislative mechanisms provide a framework to address potential adverse effects and public concerns related to those effects, that may be caused by the project.<sup>40</sup> The requesters respectfully disagree with this conclusion and instead, find the Agency made the following significant

---

<sup>40</sup> Agency Report, p 23

errors of law and fact in its analysis about the project upon which the Minister of Environment and Climate Change relied.

Without an impact assessment, the requesters submit the Minister is not in a position to evaluate the extent to which there would be negative effects on key areas of federal jurisdiction nor conclude that existing legislative mechanisms are sufficient.

### **1.0 Nuclear Licensing pursuant to the *Nuclear Safety and Control Act***

The requesters submit that the Agency made a number of factual and legal errors in its assessment of the *Nuclear Safety and Control Act* (NSCA) and its ability to provide a framework to consider the potential for adverse effects.<sup>41</sup> In light of the expanded scope of the project, a number of conclusions made in the Agency's Analysis are no longer valid.

*First*, by failing to consider all project components, including ancillary projects and activities related to the SMR's waste storage, transportation and disposal, and proposed use for international trade, the Agency's finding that "the entire Project would require a licence issued by the CNSC under powers conferred by the NSCA" is factually incorrect.<sup>42</sup>

Many of the activities proposed by NB Power are not within the ambit of the Canadian Nuclear Safety Commission's (CNSC) jurisdiction, under the *NSCA*. As a regulatory body, the CNSC's purposes are limited to regulating the development, production and use of nuclear energy.<sup>43</sup> Their licensing powers are further constrained by the provision of licences for the following enumerated uses:

- (a) possess, transfer, import, export, use or abandon a nuclear substance, prescribed equipment or prescribed information;
- (b) mine, produce, refine, convert, enrich, process, reprocess, package, transport, manage, store or dispose of a nuclear substance;
- (c) produce or service prescribed equipment;
- (d) operate a dosimetry service for the purposes of this Act;
- (e) prepare a site for, construct, operate, modify, decommission or abandon a nuclear facility; or
- (f) construct, operate, decommission or abandon a nuclear-powered vehicle or bring a nuclear-powered vehicle into Canada.<sup>44</sup>

As a result, the CNSC cannot weigh in on potential impacts of activities which are not within the scope of their licensing powers, nor included with the definition of 'nuclear facility', including the proposed SMR fleet centre, the new marine infrastructure in the Bay of Fundy and hydrogen trade with Germany.

---

<sup>41</sup> *Nuclear Safety and Control Act*, SC 1997, c 9 [NSCA]

<sup>42</sup> Agency Report, p 16

<sup>43</sup> NSCA, preamble and s 3

<sup>44</sup> NSCA, s 26(a)-(f)

While directly relevant to the project proposed by NB Power, they are not activities for which the CNSC can exercise licensing oversight.

*Second*, the Agency erred in finding the *NSCA* provides an adequate framework for the assessment of adverse and cumulative effects when it is not within the scope of the *NSCA* to consider many of the ‘effects’ as defined in the *IAA*. The *IAA* defines ‘effects’ as:

**effects** means, unless the context requires otherwise, changes to the environment or to health, social or economic conditions and the positive and negative consequences of these changes.

‘Effects’ is not a defined term in the *NSCA*. Therefore, while the CNSC reviews impacts to the health of the public and the environment as part of its licensing process and subsequently places requirements on licensees to have environmental protection programs to control, mitigate and monitor releases to the environment,<sup>45</sup> the nature of ‘effects’ it is able to oversee does not, for instance, include changes to economic conditions within federal jurisdiction (extra-provincial or international) and those incidental thereto.

*Third*, the Agency’s conclusion that “the entire Project would require a licence issued by the CNSC under powers conferred by the *NSCA*,” implies a requirement to consider adverse effects prior to decision being made to operate the SMR. This is not correct. As information obtained through ATI indicates, the proponent is currently only contemplating applying for a licence to prepare the site (anticipated in June 2023).<sup>46</sup> Unless NB Power was to concurrently seek licences to construct, operate and decommission the reactor, and additional licences to transport waste for deposit in the proposed Deep Geological Repository (DGR) in Ontario, it is not possible through the CNSC’s regulatory process to fully assess the environmental and health impacts of the project prior to project’s construction and operation.

Relative to an IA, relying on the CNSC’s review process to inform understandings of adverse effects and impacts is a major step backwards. Unlike an IA which takes into account a project’s full lifespan, the CNSC’s licensing process is narrowly defined by the stage of activity being licensed. For instance, the IA process reviews all activities within the lifespan of the project, from development through to decommissioning, including impacts of projects which are ‘direct or incidental’ to the project, (e.g., the construction of new waste storage or aquatic infrastructure for discharge) prior to any decision being made regarding its development.

In comparison, the CNSC’s licensing process is narrowly defined by the stage of activity being licensed and the life-cycle, which is divided into five licence categories for: (1) site preparation, (2) construction, (3) operations, (4) decommissioning; and (5) abandonment. The CNSC’s piecemeal licensing approach is not effective in assessing a project’s actual adverse effects because it provides no upfront review of all stages of the project’s life.

---

<sup>45</sup> Agency Report, p 8 and 20

<sup>46</sup> ATI, p 161

As stages are reviewed in isolation, it means *detailed* information about adverse effects from the project's operations and eventual decommissioning could be spaced many decades apart. For instance, if we consider the decommissioning of the SMR (which is an eventuality for any new reactor), the *Class I Nuclear Facilities Regulations* set out that at the stage of a licence to construct, the proponent only needs to provide 'information on effects to health and environment that may result from decommissioning'.<sup>47</sup> It is not until the proponent seeks a licence to decommission (following 60 years of proposed operations, in this case) that they must provide detailed information regarding the nature of nuclear substances and hazards, proposed means of decommissioning, points of emission releases (including quantities, concentrations, flow rates etc.), and proposed measures to offset effects of accidental releases.<sup>48</sup>

## 2.0 Provincial Environmental Impact Assessment

The requesters submit there are a number of errors and omissions in the Agency's finding that New Brunswick's environmental impact assessment (EIA) process would provide the public with a sufficient forum through which to raise concerns regarding the project's effects.

*First*, it was premature for the Agency to find that the provincial EIA would provide a framework to consider potential adverse effects when no decision has yet been made confirming that a Comprehensive EIA pursuant to the *Environmental Impact Assessment Regulation* of the New Brunswick *Clean Environment Act* will occur. While the Agency notes "the Proponent has indicated it expects a Comprehensive EIA will be required" and goes to great length to describe the Comprehensive EIA process, no determination has yet been made by the Department of Environment and Local Government indicating this more rigorous provincial EIA process would be required.<sup>49</sup>

The Agency also overlooks that Comprehensive EIAs are rare, with only four having been initiated to date and of the four, one remains ongoing.<sup>50</sup> As the provincial EIA regime does not require a Comprehensive EIA automatically, the requesters submit the Agency has overestimated the potential for an EIS which will "include enforceable terms and conditions to mitigate potential environmental effects for all stages of the development."<sup>51</sup>

The Agency outlines that the Proponent will be required to submit an EIA Registration Document to the Province of New Brunswick, which would include a description of the project and associated activities.<sup>52</sup> The Proponent would have to indicate in the EIA Registration Document how potentially affected

---

<sup>47</sup> *Class I Regulations*, SOR/2000-204, s 5(i) [**Class I Regulations**]

<sup>48</sup> *Class I Regulations*, s 7

<sup>49</sup> Agency Report, p 3, 4, 11

<sup>50</sup> New Brunswick, Environment and Local Government, "Comprehensive Reviews," online:

[https://www2.gnb.ca/content/gnb/en/departments/elg/environment/content/environmental\\_impactassessment/comprehensive\\_reviews.html](https://www2.gnb.ca/content/gnb/en/departments/elg/environment/content/environmental_impactassessment/comprehensive_reviews.html)

<sup>51</sup> Agency Report, p 23

<sup>52</sup> Agency Report, p 11

groups, including Indigenous nations and the public, were provided an opportunity to review and comment, and how their concerns were considered.<sup>53</sup> Then, the New Brunswick Department of Environment and Local Government would coordinate the review of the Proponent's submission, which would be conducted with the assistance of a specially constituted Technical Review Committee comprised of representatives of federal, provincial, and municipal agencies who have either a mandate or expertise related to the project.<sup>54</sup> Their review would lead to one of the following outcomes:

1. The issuance of a Certificate of Determination, with potential conditions, allowing the project to proceed;
2. The denial of the project; or
3. Further study is required by way of a Comprehensive EIA<sup>55</sup>

Only if a Comprehensive EIA was required would the following process - as described by the Agency - be engaged:<sup>56</sup>

1. The Technical Review Committee would draft guidelines to identify the environmental issues that must be considered for further study and specify the general approach the Proponent must follow in conducting the Comprehensive EIA.
2. The draft guidelines would be released for a public comment period before being finalized and issued to the Proponent.
3. At least one public meeting would be held near the location of the Project.
4. A Panel of independent experts may be retained by the government of NB to chair the meeting, receive public input, and respond to questions and concerns.
5. The Proponent would submit an EIA Report, which would be made available for public review and comment.
6. The provincial Minister of Environment and Local Government would submit a report and recommendation to the Lieutenant-Governor in Council, who would then either:
  - a. Issue an EIA approval;
  - b. Deny any approval of the Project.
7. If an approval is granted, terms and conditions may be stipulated that the Proponent must adhere to in implementing the Project.

*Second*, the Agency makes a number of errors in its setting out of the process.<sup>57</sup> Even if New Brunswick's Department of Environment and Local Government decided a Comprehensive EIA was appropriate, there remains a wide range of discretion regarding the scope of environmental issues and

---

<sup>53</sup> Agency Report, p 11

<sup>54</sup> Agency Report, p 11

<sup>55</sup> Agency Report, p 11

<sup>56</sup> Agency Report, p 11

<sup>57</sup> *Environmental Impact Assessment Regulation*, NB Reg 87-83, ss 9(1), 9(2), 10(1), 11(1), 11(2), 11(4), 13, 14, 15, 16(1), 16(2) [EIA Regulation]

process to be followed, as well as whether independent experts may or may not be retained and what conditions, if any, should accompany a final decision.

As guidance by the Department of Environment and Local Government sets out, the Technical Review Committee's role would be to "chair the meeting, receive public input, and respond to questions and concerns," and not serve as experts to provide expert evidence. This is unlike a federal IA panel, which in the context of an integrated CNSC-Agency IA, has the benefit of being able to retain independent, non-government experts.<sup>58</sup>

*Third*, the Agency's conclusion that existing legislative mechanisms would provide opportunities for public engagement, referencing that within the Comprehensive EIA process, "at least one public meeting would be held," fails to specify this public meeting opportunity occurs *after* the Minister's acceptance of the proponent's EIA report.<sup>59</sup> In other words, the public meeting is not required as part of the proponent's process of preparing the EIA report in accordance with the EIA guidelines, prepared by the Technical Review Committee. As further described in [Part IV - 4.0 Meaningful public participation](#), holding a public meeting with opportunities for the public to submit written comments is not effective nor meaningful consultation, when it occurs after the Minister has accepted the proponent's EIA as being satisfactory.

*Fourth*, while the Agency's analysis considers in much detail what could be encompassed within a comprehensive EIA, it does not contemplate the converse, that is, a setting out of environmental effects that would escape review should a Comprehensive EIA not be required and only a Certificate of Determination issued. The Agency's analysis additionally fails to recognize that there will be constitutional limits on the provincial EIA process. As we further describe in [Part III. Unaddressed Adverse Effects to Areas of Core Federal Jurisdiction](#) below, the provincial EIA process will not be the place to opine on effects which occur in another province or outside of Canada. This means the province will be restricted in the scope of conditions it can set, for instance, on adverse environmental effects should those effects not be borne within the province.

### **3.0 Nuclear Waste Oversight pursuant to the *Nuclear Fuel Waste Act***

The requesters submit the Agency made a number of errors in considering the treatment of the project's fuel waste ranging from the geographical impact of the project to the novel type of waste that would be produced should the ARC-100 SMR reach criticality.

---

<sup>58</sup> CNSC, "Memorandum of Understanding on Integrated Impact Assessment under the *Impact Assessment Act*," (2019), online: <https://nuclearsafety.gc.ca/eng/acts-and-regulations/memorandums-of-understanding/mou-impact-assessment-agency-canada.cfm>, Part 7

<sup>59</sup> Agency Report, p 11 and 18; EIA Regulation s 12 – 15; Department of Environment and Local Government, "A Guide to Environmental Impact Assessment in New Brunswick", (January 2018) online: <https://www2.gnb.ca/content/dam/gnb/Departments/env/pdf/EIA-EIE/GuideEnvironmentalImpactAssessment.pdf>, p 5

In 2002, Canada's *Nuclear Fuel Waste Act* ("NFWA") came into force.<sup>60</sup> The Act created the Nuclear Waste Management Organization ("NWMO") and specified that within 3 years of the Act coming into force, the NWMO would recommend to the Minister of Natural Resources one of three possible approaches for the management of nuclear fuel waste: (1) a deep geological disposal in the Canadian Shield, (2) storage at nuclear sites; or (3) a centralized storage, either above or below ground.<sup>61</sup>

In 2005, after a three-year study, the NWMO recommended an approach they named "Adaptive Phased Management" which had as its end point a deep geological repository. In 2007 the federal cabinet selected Adaptive Phased Management (APM) based on the NWMO's recommendation as a plan for storing and managing high-level radioactive waste management (e.g., used nuclear fuel)<sup>62</sup> APM includes transporting the waste produced by Canada's existing reactors from reactor sites to a centralized location, transferring the wastes from transportation packages to a specialized container, and emplacing the wastes in a deep geological repository.

*First*, the Agency inappropriately and incorrectly concluded that the "project would occur within the boundaries of an existing licensed nuclear facility" despite recognizing that upon final shutdown, and as part of decommissioning, "the Proponent anticipates that spent fuel would be transported to a deep geological repository for long-term management."<sup>63</sup> The Agency's findings that the project would occur 'within the bounds of an existing licensed nuclear facility' while recognizing radioactive waste would one day be transported to a DGR, are fundamentally at odds. A critical element of the project is the fact that it will create high level radioactive wastes. However, the DGR where the wastes are supposedly destined, is only proposed in the province of Ontario where two sites remain under consideration: the Revell Lake candidate site between Ignace and Dryden in Northwestern Ontario, and the South Bruce candidate site in the Municipality of South Bruce, Ontario. Thus, it is not possible to conclude that the project would be limited to the existing bounds of a nuclear facility if wastes are to be moved off-site, to the NWMO's proposed DGR.

The requesters submit the Agency cannot defer the consideration of the issue of radioactive wastes to the NWMO and Natural Resources Canada (NRCan) when communities in Ontario stand to be directly affected by the proposed project. The issue of radioactive waste generation, its transfer and disposal, requires careful consideration and the Agency cannot hive off long term off-site disposal from consideration of the project's effects.

As set out in [Part V. Public Concern](#) below, the issue of radioactive waste disposal is an issue of significant and ongoing public concern. The framing adopted by the Agency – where it splits the radioactive waste generation from the project itself – threatens to repeat the mistake wherein Canada's

---

<sup>60</sup> *Nuclear Fuel Waste Act* (S.C. 2002, c. 23) [NFWA]

<sup>61</sup> NFWA, s 12

<sup>62</sup> NWMO, "APM DGR Preliminary Description" (December 2016), online: <https://www.acee-ceaa.gc.ca/050/documents/p17520/116734E.pdf>, p 2

<sup>63</sup> Agency Report, p 4

present generation of nuclear power plants were built without regard to the management of nuclear fuel and radioactive wastes.<sup>64</sup>

*Second*, the Agency erred in relying on existing legislative mechanisms for nuclear waste oversight to demonstrate concerns regarding radioactive waste and effects will be mitigated when many significantly impactful factors remain yet to be determined. The Agency recognizes “there is no existing deep geological repository in Canada,” however, “should a site be selected” by the NWMO, “it may be deemed suitable for the future disposal of the Proponent’s used fuel from this Project (if approved), depending on waste acceptance criteria that have yet to be established and evaluated” (emphasis added).<sup>65</sup>

As legal experts and commentators have remarked, the “fundamental assumption” when the NWMO undertook its review of management options for radioactive waste was that “the volume of used nuclear fuel which needs to be managed was assumed to be limited to the projected inventory from the existing fleet of reactors.”<sup>66</sup> In other words, technologies other than existing CANDU reactors were excluded when APM was chosen as the best plan moving forward.

In light of this history, the Agency and the Minister cannot rely on the existence of the NWMO and ongoing plans to site a DGR as indications that plans will be in place to oversee the wastes produced by the ARC-100 reactor. Whether the NWMO has the mandate to accept additional, new types of nuclear fuel waste has not been confirmed by the government nor publicly discussed with communities, whose consultation to date and understanding of the DGR were prefaced on the disposal of CANDU fuel waste only.

The NWMO’s reports and descriptions for their project and proposed activities more generally are in reference to CANDU fuel waste as generated at Canada’s existing fleet of reactors. This includes their most current reports<sup>67</sup> describing their proposed operations, such as the *Deep Geological Repository Conceptual Design Report Crystalline / Sedimentary Rock*,<sup>68</sup> the *Deep Geological Repository Transportation System Conceptual Design Report Crystalline / Sedimentary Rock*<sup>69</sup> (the “Concept Reports”) and the *Confidence in Safety – Revell Site*<sup>70</sup> report.

---

<sup>64</sup> See K. Blaise and S-P Stensil, “[The Evolution of Decommissioning Planning](#): Tracing the Requirements to Consider Radioactive Wastes and Social Risk of Nuclear Power Plants” (2021) in: Black-Branch J, Fleck D (eds) *Nuclear Non-Proliferation in International Law – Volume VI*, T.M.C. Asser Press

<sup>65</sup> Agency Report, Footnote 3

<sup>66</sup> K. Blaise and S-P Stensil, “[Small Modular Reactors in Canada](#): Eroding Public Oversight and Canada’s Transition to Sustainable Development” (2021) in: Black-Branch J, Fleck D (eds) *Nuclear Non-Proliferation in International Law – Volume V*, T.M.C. Asser Press, p 225; Nuclear Waste Management Organization, “Assessing the Options—The NWMO Assessment Team Report” (June 2004)

<sup>67</sup> See online: [nmwo.ca/en/reports](http://nmwo.ca/en/reports)

<sup>68</sup> APM-REP-00440-0211-R000, September 2021

<sup>69</sup> APM-REP-00440-0209 R001, September 2021

<sup>70</sup> NWMO-TR-2022-14, March 2022



Similarly, it was CANDU fuel waste that was referenced during the three-year study period, from 2002 to 2005 during which the NWMO purported to have consulted with Canadians. However, no such consultations were held in the Kenora District and likewise, the selection of the South Bruce site was made without any consultation with residents. More specifically, the Concept Reports issued in 2021 describe transportation containers, transportation, processing the fuel waste in the “used fuel packaging plant”, and the used fuel container and used fuel container placement in a geological repository only in reference to CANDU fuel waste.

Neither of the NWMO’s Concept Reports include any reference to the wastes that would be generated by ARC-100 design reactor.<sup>71</sup> Nor does the recent *Confidence in Safety - Revell Site* report released in 2022 reference the ARC-100 design. The only document posted by the NWMO that references the ARC-100 reactor is the annual *Watching brief on advanced fuel cycles and alternative waste management technology – 2021 Update* where at Table 4, it includes the following one-line description of the ARC-100 reactor with a three-word description of the fuel:<sup>72</sup>

**Table 2:** Excerpt from NWMO *Watching Brief on Advanced Fuel (2022)*

Table 4: SMRs currently under evaluation in Canada

Reactor	Vendor	Fuel/Coolant	Type	CNSC vendor design review status [CNSC, 2021]
ARC-100	ARC Nuclear Canada Inc.	Metal/Liquid sodium	Fast reactor	Phase 1 complete

To the best of our knowledge, this report and this reference to the ARC-100 reactor has never been presented in any public session in northern Ontario, and the NWMO has made no effort to make residents in the region aware of the possibility of these very different fuel wastes being added to the inventory the NWMO intends to place in a deep geological repository in Kenora District.

While recognizing the DGR itself will be the subject of its own project-level assessment, at some point following the selection of a host community, in light of the shifting baseline regarding new fuel wastes in the DGR, an IA for the ARC-100 project would allow critically lacking details about waste, its characteristics, amounts and adverse effects to be fully understood and studied.

An IA would allow questions, such as the following, to be publicly weighed and reviewed by independent experts:

- What are the characteristics of fuel wastes and reprocessing wastes to be generated by the ARC-100 operations?

<sup>71</sup> APM-REP-00440-0211-R000, September 2021; APM-REP-00440-0209 R001, September 2021

<sup>72</sup> NWMO, “Watching brief on advanced fuel cycles and alternative waste management technology – 2021 Update,” (2021), online: <https://www.nwmo.ca/~media/Site/Reports/2022/03/28/14/10/Watching-brief-on-advanced-fuel-cycles-and-alternative-waste-management-technology--2021-update--EN.ashx?la=en>

- How much additional waste would be created and how would this change community engagement to date, where only CANDU wastes were considered?
- How do the wastes differ from the CANDU wastes which have been contemplated for transportation, processing and disposition at a potential DGR?
- What are the consequences of these additional and novel wastes for the long term safety case and to community consultations for the proposed DGR?

*Third*, the novel challenges posed by the ARC-100 SMR design were not sufficiently considered by the Agency. The first request noted that the ARC SMR design's choice of sodium as a coolant rather than the more conventional choice of water presents several unique issues; sodium's major disadvantage is that it reacts violently with water and burns if exposed to air. The challenges extend to the wastes created by these reactors.

The 2022, U.S. expert panel report notes that sodium-cooled fast reactors like the ARC-100 would produce large volumes of irradiated sodium waste that would require treatment and disposal; sodium-bonded spent fuel is not suitable for direct disposal (i.e., in a DGR) and would require treatment by methods not yet technically mature at the industrial scale. Due to the chemical reactivity of the sodium-bonded used fuel, reprocessing would be required to remove the sodium so as to avoid adverse chemical reactions or explosions underground should it be placed in a DGR; such occurrences which could compromise the integrity of a final repository and so the long-term safety case.

Shut-down sodium-cooled reactors have proven difficult to decommission. In the US, the EBR-II reactor, on which the ARC-100 is based, was shut down permanently in 1994 but to date it has been unfeasible to extract the sodium metal from the highly radioactive spent fuel. The challenge is to safely dispose of this material without causing underground explosions due to sodium-water reactions, as happened with the sodium-cooled Dounreay reactor in Scotland. In November 2022, radioactive particles were found on the Dounreay foreshore, more than four decades after the reactor waste exploded.<sup>73</sup> A similar accident with the proposed ARC-100 reactor could result in widely spread radioactive contamination next to the Bay of Fundy.

#### **4.0 Fostering Reconciliation and the Protection of Indigenous Rights**

The requesters submit the Agency failed to adequately grapple with the issues raised by the Indigenous groups in New Brunswick who engaged in the first request and its consultation process: the Passamaquoddy Recognition Group representing the Peskotomuhkati Nation at Skutik, the Wolastoq Grand Council, and Mi'gmawe'l Tplu'taqnn (MTI), which represents nine Mi'gmaq First Nation communities in New Brunswick. All three groups strongly supported the first request.

---

<sup>73</sup> G. Calder, "Councillor wants to know why there has been an increase in radioactive particles found on Dounreay foreshore," (4 November 2022), online: <https://www.johnogroat-journal.co.uk/news/councillor-wants-to-know-why-there-has-been-an-increase-in-r-292436/>

Among the concerns raised by the Indigenous groups was that the project could impact Aboriginal and treaty rights. The Agency responded that “Potential adverse impacts on the section 35 rights of Indigenous peoples will be considered in the CNSC process under the NSCA, which includes consultation with Indigenous groups,” stating that this would include Commission hearings, in addition to the provincial EIA process. Other consultation opportunities mentioned included NRCan’s Indigenous Advisory Council and an “engagement session” about SMRs in 2020 offered by NRCan to several Indigenous groups including the Peskotomuhkati Nation at Skutik (Passamaquoddy).<sup>74</sup>

The requesters submit the Agency also failed to consult with First Nations outside of New Brunswick who by virtue of the project’s waste disposal plans, will be directly affected. By finding the project was limited to the existing boundaries of the Point Lepreau nuclear site, the Agency failed to discharge its duty to consult with other First Nations who may be impacted due to fuel production, waste disposal or transportation. For instance, the Agency’s Analysis made no mention of the fact that the Canadian Nuclear Laboratory (CNL) at Chalk River in Ontario is also part of the ARC-100 project.

According to an announcement made on July 27, 2022, several weeks after the first request was submitted to the Minister, CNL entered into an MOU to conduct fuel research for the ARC-100 reactors, to “to advance the fuel development and manufacturing processes to produce fuel for ARC Canada’s advanced small modular reactor technology.”<sup>75</sup> Although no detailed information is available about the Chalk River activities, the research is clearly integral to the ARC-100 project development and therefore the Agency had a constitutional duty to consult with First Nations whose rights and traditional lands may be impacted by new activities at the Chalk River site.

*Second*, the Agency failed to consider how the project would interact with statements made by Indigenous nations and organizations about the transfer of radioactive materials in their territory. These include the Joint Declaration between the Anishinabek Nation and the Iroquois Caucus on the transport and abandonment of radioactive waste which states that “radioactive waste will not be transported, exported or imported throughout our territories by road, rail, water or other means of transportation” and that “Transport of nuclear waste should be strictly limited and decided on a case-by-case basis with full consultation with all those affected.”<sup>76</sup>

The Revell Site candidate area for the DGR in Northwestern Ontario is at the headwaters of the Turtle/Rainy River watershed and the Wabigoon watershed in the heart of Grand Council Treaty #3 (GCT#3) territory. Its selection for the DGR would necessitate two to three transport truck loads per day traversing northern Ontario for a period of fifty years or longer, including the Robinson-Huron, Robinson-Superior, Nishnawbe Aski Nation and GCT#3 treaty territories. Therefore, the Agency ought also to have considered Nishnawbe Aski Nation’s chiefs-in-assembly resolution passed in August 2022

---

<sup>74</sup> Agency Report, p. 19

<sup>75</sup> Canadian Nuclear Laboratories, “CNL Partners with ARC Canada to Advance Fuel Development,” (27 July 2022) online: <https://www.cnl.ca/cnl-partners-with-arc-canada-to-advance-fuel-development/>

<sup>76</sup> See the Joint Declaration here: [http://www.ccnr.org/Joint\\_Declaration\\_pack.pdf](http://www.ccnr.org/Joint_Declaration_pack.pdf)

that “vehemently” opposes the possibility of an underground repository for nuclear waste in Northern Ontario.<sup>77</sup>

## 5.0 Serious and irreversible risks from ARC-100 Fuel

The requesters submit the Agency erred when it failed to include the fuel within its analysis, omitting a range of serious and irreversible effects to areas of core jurisdiction.

In its Analysis Report, the Agency discusses the ARC-100 fuel as “metallic uranium alloy fuel” when in fact, the ARC design is proposed to be fueled by High Assay Low-Enriched Uranium (HALEU) fuel. As a result of this critical distinction, the Agency is misinformed about the expertise of Canada’s nuclear regulator, the CNSC, and the NWMO to oversee this fuel and its effects.

The CNSC, in addition to the NWMO, have no experience with HALEU as it has never been used in commercial reactors in Canada. HALEU is different from the natural (unenriched) uranium used by CANDU reactors, and the low-enriched uranium used by light-water reactors globally.

Enriched fuel contains more U-235 uranium that can sustain a chain reaction. The fuel for current light-water reactors is enriched to no more than 5 percent while HALEU is enriched between 5 and 20 percent. The ARC-100 relies on HALEU of up to 15.5 percent enrichment. HALEU is considered permissible in commercial power reactors but raises nuclear weapons proliferation concerns because of the higher risk of using enriched uranium for nuclear explosions.

As set out in the expert panel report of the U.S. National Academies, introduced earlier, expanding the global use of HALEU would potentially augment nuclear weapons proliferation and security risks. The only current supply of this material is in Russia, however sanctions will likely make that Russian fuel unavailable in the foreseeable future. The U.S. has no capacity to manufacture HALEU fuel, and although the U.S. is planning to ramp up to manufacture HALEU to supply the SMR designs being developed in their country, it is unknown if HALEU will be available to supply fuel for reactor projects in Canada in the coming decades.

Given that the planned HALEU fuel is likely to be unavailable in the planned time frame, ARC will need to rely on alternative fuel types. The ARC-100 product brochure lists alternative sources of fuel instead of

---

<sup>77</sup> M. McLeod, “Nishnawbe Aski Nation opposes possible site for storage of nuclear waste,” *The Globe and Mail* (10 August 2022), <https://www.theglobeandmail.com/politics/article-nishnawbe-aski-nation-opposes-possible-site-for-storage-of-nuclear/>; T. Talaga, “The next Land Back battleground will be north of Lake Superior, as Chiefs say no to nuclear waste on their traditional lands,” (11 August 2022), online: <https://www.theglobeandmail.com/opinion/article-the-next-land-back-battleground-will-be-north-of-lake-superior-as/>

HALEU:<sup>78</sup>

- the waste created by light water reactors (which still contains about 95-97% of its energy potential, unfissioned);
- the large, existing, global stockpile of depleted uranium-238; and
- the nuclear material removed from weapons, which currently creates a serious storage and security problem.

The first source involves reprocessing, the second source implies that uranium-238 would be converted into plutonium-239, and the third source raises concerns related to importing this material into Canada (recall the heated political controversy over the Parallax Project more than two decades ago, that proposed to import large quantities of weapons grade plutonium from dismantled U.S. and U.S.S.R. warheads for use as fuel in CANDU reactors).<sup>79</sup>

All these fuel types – including HALEU – are materials that would need to be imported, as Canada does not have a domestic supply nor plans to develop the supply in Canada. As discussed in greater detail in [Part III. Unaddressed Adverse Effects to Areas of Core Federal Jurisdiction](#) below, the Agency erred when it failed to include the fuel within its analysis and thus omitted a range of serious and irreversible effects to areas of federal jurisdiction.

## 6.0 Mischaracterization of ARC-100 reactor design state of development

The requesters submit the Agency erred when it re-stated NB Power's incorrect assertion that the EBR-II reactor, the precursor to the ARC-100 design, "successfully supplied energy to the grid for thirty years."<sup>80</sup> This mischaracterization of the ARC-100 design's level of technology development is significant because it gives the false impression that the reactor design is proven to have operated safely in a commercial setting, which is not the case.

The EBR-II operated in a research setting and was never connected to a commercial electricity grid. It could not have been, because the EBR-II reactor operated on uranium fuel enriched up to 65 percent, which is close to weapons-grade fuel and not permissible in commercial power reactors, which are limited to use fuel enriched to 20 percent or less. As noted earlier, the ARC-100 design calls for HALEU fuel enriched to less than 20 percent.

In fact, five decades and more than \$50 billion in development spending on attempts to commercialize a sodium-cooled reactor in the past have resulted not only in failure but also numerous dangerous fires

---

<sup>78</sup> "ARC-100: A Sustainable, Cost-Effective Energy Solution for the 21st Century" (ARC product brochure, no date), online: <https://crednb.files.wordpress.com/2021/02/arc-100-product-brochure.pdf>

<sup>79</sup> See "Weapons-Grade Plutonium Flown Across Southern Canada" in Democracy Now (18 Jan 2000), online: [https://www.democracynow.org/2000/1/18/headlines/weapons\\_grade\\_plutonium\\_flown\\_across\\_southern\\_canada](https://www.democracynow.org/2000/1/18/headlines/weapons_grade_plutonium_flown_across_southern_canada)

<sup>80</sup> Agency Report, p. 22.

and explosions due to the reactivity of the sodium coolant.<sup>81</sup> There is no successfully operating commercial sodium-cooled reactor in existence today that operates on fuel enriched to less than 20 percent.<sup>82</sup>

### III. UNADDRESSED ADVERSE EFFECTS TO AREAS OF CORE FEDERAL JURISDICTION

The requesters submit that in light of the material changes to the project and revised description of the project, the adverse effects within federal jurisdiction raised in the first request, including impacts to Indigenous rights, fish and fish habitat and migratory birds, ought to be reassessed by the Agency. Additional effects to areas of federal jurisdiction have arisen as a result of the material changes to the project that must be accounted for in the Minister's decision under subsection 9(1) of the *IAA*.

As set out below, there are a number of adverse effects posed to areas of federal jurisdiction including out of province and out of country impacts, that make it imperative that this project be properly subject to an IA. We submit a federal IA is also an appropriate forum for review of this project by virtue of activities relating to nuclear energy being of federal interest, as declared by Parliament under the *Constitution Act, 1867*.<sup>83</sup>

#### 1.0 A change to the environment in another province

The proposed project poses effects within federal jurisdiction by virtue of causing a change to the environment that would occur in another province.<sup>84</sup> As a result of a material change in the project, wherein the proponent seeks a fleet support centre for the deployment of ARC SMRs elsewhere in Canada and the potential disposal of waste out of the province, the Agency's finding that "no lands outside of New Brunswick or Canada would be directly impacted and that "potential impacts are expected to be the same as currently present" is no longer valid.<sup>85</sup>

The requesters submit the deployment of ARC SMRs elsewhere in Canada amounts to interprovincial trade, and as was observed by Justice Pigeon in *Interprovincial Cooperatives*, "where business contracts affect interprovincial trade, it is no longer a question within provincial jurisdiction. The matter becomes

---

<sup>81</sup>T.B. Cochran, H.A. Feiveson, W. Patterson, G. Pshakin, M.V. Ramana, M. Schneider, T. Suzuki, F. von Hippel (2010). Fast Breeder Reactor Programs: History and Status. A research report of the International Panel on Fissile Materials. February, 128 pp. Available at: <https://fissilematerials.org/library/rr08.pdf>

<sup>82</sup> E. Lyman (2021). Advanced isn't always better: Assessing the Safety, Security, and Environmental Impacts of Non-Light-Water Nuclear Reactors. Union of Concerned Scientists, March. 148 pp. Available at: <https://www.ucsusa.org/resources/advanced-isnt-always-better>

<sup>83</sup> *NSCA*, s 71; *Nuclear Energy Act*, RSC 1985, c A-16, s 18; *Constitution Act, 1867*, 92(10)(c)

<sup>84</sup> *IAA*, s 2(b)(ii)

<sup>85</sup> Agency Report, p 16

one of federal jurisdiction.”<sup>86</sup> The impacts of this trade are not effects that would be overseen by a provincial EIA nor the CNSC by virtue of its more narrow, regulatory licensing proceeding.

The requesters submit there has also been a dearth of information provided to the residents in the DGR siting areas being investigated by the NWMO and along the transportation routes, including information about the volume, nature, characteristics and potential additional hazards associated with the wastes to be generated by a very different reactor design, i.e., the ARC-100. The onus is certainly not on these residents to seek out information about novel reactors being considered in other provinces where the proponent is identifying the NWMO proposed deep geological repository as the destination for the wastes while the NWMO is omitting any such identification from their own information programs. The NWMO has made known its intention to select a site in 2024 and to immediately commence the project assessment and licencing processes. This date was selected without consulting residents at the candidate sites, and it is unclear what the NWMO’s deadline is for achieving what the NWMO has called a “compelling demonstration of willingness” - wherein a potential host community would express its informed support for the NWMO’s project. The NWMO has repeatedly stated that this is a necessary condition to their moving forward and yet the definition of “willingness”, has not been defined.

In addition to all of the concerns that residents have expressed about potential for releases of radioactivity and other contaminants during transportation, processing and emplacement in a DGR of CANDU reactor wastes, residents would reasonably be expected to have additional concerns about additional hazards associated with the chemistry and the potential for criticality of these wastes, their burnup rate and variations in the thermal load compared to CANDU fuels, and the effect of the waste chemistry on fuel structures and container viability over the long-term. These are significant questions related to safety during the operational period and the long-term safety case.

Therefore, as there will be impacts to areas of federal jurisdiction by virtue of interprovincial effects, wherein the activities of one province will affect another, this project ought to be designated for an IA.

## **2.0 A change to the environment outside of Canada**

The proposed project poses effects within federal jurisdiction by virtue of causing a change that would occur outside Canada.<sup>87</sup> As a result of material changes in the project, including the proposed fleet support centre for the deployment of ARC SMRs for international markets and use of the ARC SMR for production of hydrogen for international markets; and, the need to source fuel from outside of Canada, the Agency’s finding that “no lands outside of New Brunswick or Canada would be directly impacted” is no longer valid.<sup>88</sup>

---

<sup>86</sup> *Interprovincial Co-operatives Ltd. et al v R.*, [1976] 1 SCR 477 at 513-514

<sup>87</sup> IAA, s 2(b)(iii)

<sup>88</sup> Agency Report, p 16

The requesters submit the deployment of ARC SMRs for international markets and its relevance to the Canada-Germany Hydrogen Alliance (as discussed in [Part I. Background and Material Change in Project](#)) triggers Canada's obligations under the *Canada-European Union Comprehensive Economic and Trade Agreement* ("CETA").<sup>89</sup>

Article 24.2 of the CETA sets out the intention that international trade advance sustainable development and that the parties seek to promote sustainable development in their actions:

#### **Article 24.2 – Context and objectives**

The Parties recognise that the environment is a fundamental pillar of sustainable development and recognise the contribution that trade could make to sustainable development. The Parties stress that enhanced cooperation to protect and conserve the environment brings benefits that will:

- (a) promote sustainable development;
- (b) strengthen the environmental governance of the Parties;
- (c) build upon international environmental agreements to which they are party; and
- (d) complement the objectives of this Agreement. [emphasis added]

This means the ARC-100 SMR project ought to be reviewed in line with the principle of sustainable development and whether it helps or hinders Canada's sustainable development goals. As described by impact assessment expert and scholar, Dr. Robert Gibson, "As an encapsulation of what is needed by present and future generations for lasting, well-being, sustainability can represent the overall long-term public interest objective."<sup>90</sup>

Presently, the IAA is uniquely positioned to assess the project's sustainability contributions pursuant to Article 24.2 of CETA, as one of the core purposes of the Act is that projects 'foster sustainability' (see further discussion below in [Part IV. Granting the Designation Aligns with the Purposes of the IAA](#)).

Furthermore, Articles 24.3 and 24.5 of CETA encourage 'high levels of environmental protection' and that parties not derogate from environmental law to 'encourage trade, or the establishment, acquisition, expansion or retention of an investment in its territory.'

#### **Article 24.3 – Right to regulate and levels of protection**

The Parties recognise the right of each Party to set its environmental priorities, to establish its levels of environmental protection, and to adopt or modify its laws and policies accordingly and in a manner consistent with the multilateral environmental agreements to which it is party and

---

<sup>89</sup> Government of Canada, "Text of the Comprehensive Economic Trade Agreement," (2018), online: <https://www.international.gc.ca/trade-commerce/trade-agreements-accords-commerciaux/agr-acc/ceta-aecg/text-texte/toc-tdm.aspx?lang=eng>

<sup>90</sup> M. Doelle and A. Sinclair (eds), "The Next Generation of Impact Assessment: A Critical Review of the Canadian Impact Assessment Act," p 308 [Doelle & Sinclair]



with this Agreement. Each Party shall seek to ensure that those laws and policies provide for and encourage high levels of environmental protection, and shall strive to continue to improve such laws and policies and their underlying levels of protection [emphasis added].

[...]

#### **Article 24.5 – Upholding levels of protection**

1. The Parties recognise that it is inappropriate to encourage trade or investment by weakening or reducing the levels of protection afforded in their environmental law.
2. A Party shall not waive or otherwise derogate from, or offer to waive or otherwise derogate from, its environmental law, to encourage trade or the establishment, acquisition, expansion or retention of an investment in its territory [emphasis added]
3. A Party shall not, through a sustained or recurring course of action or inaction, fail to effectively enforce its environmental law to encourage trade or investment.

The requesters are concerned, based on information received through ATI, that the Proponent is advocating against an IA designation by virtue of the time necessary to complete the more rigorous process. As notes from a meeting indicate, the time for an IA versus provincial comprehensive EIA (if one occurred) would be “3 vs 5” years.<sup>91</sup> In fact, speaking to the media in response to the first request, the ARC company stated that “an additional assessment wouldn't compromise ARC's ability to get a first reactor operating at Lepreau by 2030.”<sup>92</sup>

Therefore, the requesters submit it would be contrary to international trade obligations set out in CETA should any weight be given to the time it takes to complete an impact assessment, whether provincial or federal, in making a decision on a designation request under subsection 9(1) of the *IAA*. To the contrary, Canada is obligated to encourage high levels of environmental protection and per Article 24.12, “taking into account any IA carried out by the Parties.”

#### **Article 24.12 – Cooperation on environment issues**

1. The Parties recognise that enhanced cooperation is an important element to advance the objectives of this Chapter, and commit to cooperate on trade-related environmental issues of common interest, in areas such as: the potential impact of this Agreement on the environment and ways to enhance, prevent, or mitigate such impact, taking into account any impact assessment carried out by the Parties;

Ensuring that the standards and principles set out in the articles of CETA are met is a matter of federal jurisdiction, and further affirms our request that this project be designated for an IA.

---

<sup>91</sup> ATI, p 45

<sup>92</sup> J. Poitras, “Nuclear opponents taking 'best shot' to slow approval of N.B.'s small reactors,” 8 December 2022, online: <https://www.cbc.ca/news/canada/new-brunswick/small-nuclear-reactors-nb-approval-slow-1.6677357>

#### IV. GRANTING THE DESIGNATION ALIGNS WITH THE PURPOSES OF THE IAA

The requesters submit the Agency's Analysis and the December 2022 decision of the Minister failed to have regard to core purposes and principles of the IAA, as set out in section 6.

In making the decision on this request, the onus is on the Minister to ensure a designation request decision is responsive to the statutory purposes of the IAA, including the promotion of cooperation and coordination among provincial and federal governments, the precautionary principle, the fostering of sustainability, and advancement of meaningful public participation.

##### 1.0 Promoting cooperation between federal and provincial governments

The IAA contains provisions that facilitate cooperation and coordination among federal and provincial levels of government, including the establishment of joint review panels.<sup>93</sup> This is reflected in one of the purposes of the IAA, which is to “promote cooperation and coordinated action between federal and provincial governments.”<sup>94</sup> There are a number of reasons why designating this project for an IA would serve to advance this purpose, while respecting the legislative competence of each level of government.

*First*, as both levels of government have important interests in the project, cooperation would not only be advantageous in the circumstance, but, we submit, necessary. The federal government has an interest by virtue of its jurisdiction over nuclear, as authorized under the *Constitution Act, 1867*, and provincial governments have also indicated interest, demonstrated by New Brunswick's reference to the potential for a Comprehensive EIA, and the existence of Ontario and New Brunswick's joint *Strategic plan for the deployment of small modular reactors*.

Provincial jurisdiction is broad since provinces have jurisdiction over “property and civil rights in the province”<sup>95</sup>, which gives them jurisdiction over most types of projects. However, the federal government also has jurisdiction - even if the project is predominantly under provincial jurisdiction - should there be effects within federal jurisdiction. Furthermore, Parliament has declared it has jurisdiction over:

[a]ny work or undertaking constructed for the development, production, or use of nuclear energy or for the mining, production, refinement, conversion, enrichment, process, reprocess, possession or use of a nuclear substance or for the production, possession or use of prescribed equipment or prescribed information.<sup>96</sup>

*Second*, in many instances, as highlighted above in [Part II. Errors of Fact and Law in the Agency's Analysis](#), there remain gaps in the existing legislative mechanisms that can assess the projects and its effects, because of limits on either the CNSC's jurisdiction as a regulatory body or the province, by virtue

<sup>93</sup> IAA, ss 29, 31, 39; *MiningWatch Canada v Canada (Fisheries and Oceans)*, [2010 SCC 2](#), para 41

<sup>94</sup> IAA, s 6(1)(e)

<sup>95</sup> *Constitution Act, 1867*, ss 91(29) and 92(10)(c)

<sup>96</sup> NSCA, s 71; *Nuclear Energy Act*, RSC 1985, c A-16, s 18

of constitutional division of powers. As a result, the Agency does not have the requisite basis to recommend against granting the designation to the Minister, since there are, fundamentally, areas of concern and effects that can only be assessed by means of an IA.

*Third*, the province and Agency have already recognized the need for cooperation. As the Agency notes, should there be a Comprehensive EIA:

Any specific benchmarks and/or standards established for the EIA review would be based on the requirements and recommendations provided by the appropriate members of a technical review committee. This would include input from both provincial and federal representatives for many of the issues considered, although some of them would rely heavily (if not exclusively) on federal input, such as long-term management of radioactive wastes and non-proliferation of nuclear weapons [emphasis added].<sup>97</sup>

The Province of New Brunswick also indicated that on issues such as the management of nuclear waste, it would “rely heavily (if not exclusively) on federal input.”<sup>98</sup>

*Fourth*, mechanisms for achieving cooperative federalism have been present in predecessor IA legislation, including the *Canadian Environmental Assessment Act* of 1992, and the *Canadian Environmental Assessment Act, 2012*.<sup>99</sup> There is also precedent for a joint federal-provincial assessment at the Point Lepreau site. In 1985, a joint review panel provided their environmental assessment report to both the provincial and federal Ministers of the Environment in response to a proposed second reactor at the Point Lepreau nuclear generating station.<sup>100</sup>

By virtue of being a joint assessment, they were able to “direct certain recommendations to federal and provincial administrators of environmental impact assessment.”<sup>101</sup> In addition to project specific recommendations to ameliorate adverse effects, the joint panel also made policy recommendations. For instance, the joint panel directed the federal government to undertake a public policy review of nuclear energy within Canada’s National Energy Policy and to the province, an economic study to identify “high technology engineering and technical opportunities for New Brunswick firms” associated with Lepreau II. These types of recommendations would be outside the purview of the provincial EIA process and not within the scope of the CNSC licensing authorizations, should an IA not be required.

---

<sup>97</sup> Agency Report, p 10

<sup>98</sup> Agency Report, p 21

<sup>99</sup> *Environmental Protection and Enhancement Act*, RSA 2000, c E-12, ss 2(h), 57; *Environmental Assessment Act*, RSO 1990, c E.18, s 3.1.

<sup>100</sup> [https://publications.gc.ca/collections/collection\\_2017/acee-ceaa/En105-33-1985-eng.pdf](https://publications.gc.ca/collections/collection_2017/acee-ceaa/En105-33-1985-eng.pdf)

<sup>101</sup> *Ibid* p 4

## 2.0 Adherence to the precautionary principle

The requesters submit the Minister has an obligation to make a decision that furthers the precautionary principle. In rejecting the first request, however, the Minister unreasonably exercised his discretion by relying on unspecified and hypothetical processes, and by unreasonably disregarding findings of potential adverse effects to areas of federal jurisdiction.

We submit the precautionary principle is directly relevant to this request given the many unknowns associated with the reactor's waste and its ultimate disposal, and the fact that the intent to reprocess the ARC-100 used fuel was not mentioned by NB Power as part of the Agency's review.

The precautionary principle is a well-established principle of Canadian law, directly applicable to the interpretation of impact assessment legislation.<sup>102</sup> The precautionary principle is reflected as a core purpose of the *IAA*, which requires projects to be "considered in a careful and precautionary manner to avoid significant adverse environmental effects,"<sup>103</sup> in addition to being embedded in the Minister's decision making on designation requests. As set out in subsection 9(1), the Minister is authorized to subject a project to the *IAA* if, in the Minister's opinion, the project *may* impact on areas within federal authority. In other words, the Act does not require proof of federal effects to order an assessment – only the possibility of effects.<sup>104</sup> On this basis, we submit there are a number of reasons why the application of the precautionary principle merits the project being designated for an IA.

*First*, as a purpose of the *IAA*, the Minister is obligated to exercise their powers in a manner that "applies the precautionary principle."<sup>105</sup> Though not defined in the *IAA*, the Supreme Court of Canada<sup>106</sup> in *Castonguay* described the principle as follows:

This emerging international law principle recognizes that since there are inherent limits in being able to determine and predict environmental impacts with scientific certainty, environmental policies must anticipate and prevent environmental degradation.<sup>107</sup>

---

<sup>102</sup> *Spray-Tech; Castonguay Blasting Ltd. v Ontario*, 2013 SCC 52; *Croplife Canada v Toronto*, 2005 CanLII 15709 (ONCA), *Alberta Wilderness Assn v Canada (Minister of Environment)*, 2009 FCJ 876; *Environmental Defence Canada v Canada (Minister of Fisheries and Oceans)*, 2009 FCJ 1052; *R. v. Kingston (Corp. of the City)*, 2004 CanLII 39042 (ONCA); *Alberta Foothills Properties Ltd. v. Director, Southern Region, Operations Division, Alberta Environment and Sustainable Resource Development* (20 December 2013), Appeal No. 11-179-R (A.E.A.B.); *Atlantic Salmon Federation (Canada) v. Newfoundland (Environment and Climate Change)*, 2017 NLTD(G) 137; *Centre québécois du droit de l'environnement c. Oléoduc Énergie Est Ltée*, 2014 QCCS 4398; *Wier v. British Columbia (Environmental Appeal Board)*, 2003 BCSC 1441; *Dawber v. Ontario (Director, Ministry of the Environment)* (2007), 28 C.E.L.R. (3d) 281; affd. (2008), 36 C.E.L.R. (3d) 191 (Ont.Div.Ct.); leave to appeal refused (Ont. C.A. File No. M36552, November 26, 2008)

<sup>103</sup> *IAA*, s 6(1)(l)

<sup>104</sup> Doelle & Sinclair, p 105

<sup>105</sup> *IAA*, s 6(1)(d)

<sup>106</sup> *114957 Canada v Hudson (Ville)*, 2001 SCC 40, [2001] 2 SCR 241, paras 30-32

<sup>107</sup> *Castonguay Blasting Ltd. v Ontario*, 2013 SCC 52, [2013] 3 SCR 323, para 20

In Canadian law, the principle has been adopted and endorsed by courts across Canada, based on the 2001 decision of the Supreme Court of Canada in *Spray-Tech* where the court stated:

In order to achieve sustainable development, policies must be based on the precautionary principle. Environmental measures must anticipate, prevent and attack the causes of environmental degradation. Where there are threats of serious or irreversible damage, lack of scientific certainty should not be used as a reason for postponing measures to prevent environmental degradation.<sup>108</sup>

*Second*, proceeding with the development of new nuclear reactors, absent an IA to address potentially irreversible harm is the antithesis of precautionary. The Agency and Minister are obligated to exercise their jurisdiction in a way that furthers precaution. We submit that in light of known information gaps, including on fuel and waste products, and findings by federal agencies that there *is* the potential for federal effects, the Minister must exercise his jurisdiction to grant the designation pursuant to section 9(1) of the IAA.

As noted in submissions from other government agencies received in response to the first request, there was the potential for adverse effects to areas of federal jurisdiction:

- Findings by the Department of Fisheries and Oceans (DFO) noted that the project has the potential of causing death of fish and/or harmful alterations, disruption or destruction of fish habitat and/or any of the prohibitions of SARA<sup>109</sup>
- Findings by Environment, Climate Change Canada noted potential environmental effects caused by reactor cooling water discharge and adverse effects to water quality and sensitive ecosystem receptors<sup>110</sup>
- Findings by Health Canada noted potential adverse effects on human health and to the biophysical environment<sup>111</sup>

*Third*, the Agency unjustifiably relied on statements provided by the SMR vendor, overlooking that the role of IA is to test a proponent's claims with respect to impacts. Applying the precautionary principle means the proponent whose project may potentially cause environmental damage bears the burden of demonstrating no harm to the environment.

As we discussed above in [Part II - 6.0 Mischaracterization of ARC-100 reactor design state of development](#), the Agency's analysis notes "According to information on ARC Clean Energy Canada Inc.'s website, the Experimental Breeder Reactor-II was a sodium-cooled fast-reactor developed by the United

---

<sup>108</sup> 8114957 *Canada Ltee (Spray-Tech) v Hudson (Ville)* 2001 SCC 40

<sup>109</sup> Fisheries & Oceans Canada, "Federal Authority Advice Record – Designation Request under IAA" (1 Nov 2022), para 6

<sup>110</sup> Environment & Climate Change Canada, "Federal Authority Advice Record – Designation Request under IAA" (25 Oct 2022), para 6

<sup>111</sup> Health Canada, "Federal Authority Advice Record – Designation Request under IAA" (11 Oct 2022), para 6

States government’s Argonne National Labs, and successfully supplied energy to the grid for thirty years.”<sup>112</sup> In light of evidence to the contrary provided by the requester in the first request,<sup>113</sup> the Agency should have instead raised questions about legitimacy of claims, pointing to a need for a public IA process, before making conclusions on the commercial viability of the project.

### **3.0 Fostering sustainability**

The requesters submit the December 2022 Decision failed to have regard to a core purpose of impact assessment, which is the fostering of sustainability.<sup>114</sup> There is no reference to sustainability, despite it being repeatedly raised by the requesters,<sup>115</sup> nor analysis which sets out how denial of the first request aligned with sustainability.

The requesters submit any decision pursuant to section 9(1) of the *IAA* must set out how it aligns with the goal of sustainability; this is necessary to ensure that the Agency’s recommendations and Minister’s decision are consistent with the mandatory purposes of the *IAA*.

The need for a sustainability assessment of the project, as would occur should an IA be required, is further buttressed by CETA Articles 24.2 and 24.12 which state as an ambition of trade, that trade contribute to sustainable development and that potential impacts of trade on the environment take into account ‘any impact assessment’ carried out by the parties. We reiterate the *IAA* is uniquely positioned to assess the project’s sustainability contributions, as sustainability assessments have not been a feature of either the CNSC licensing scheme or provincial EIA process.

### **4.0 Meaningful public participation**

The requesters submit licensing by the CNSC and a provincial EIA do not place the same emphasis on public participation and thus, would be deficient in comparison the *IAA*’s purpose that ‘meaningful public participation’ occur during an IA. Meaningful public participation is also a prerequisite if trust in this project is to be built.

Opportunities for the public to participate occur throughout the multi-staged IA process,<sup>116</sup> not simply at a licensing hearing that itself is tailored to a specific component and stage of the project. Similarly, as discussed in section [Part II - 2.0 Provincial Environmental Impact Assessment](#) above, for provincial EIA

---

<sup>112</sup> Agency Report, p 22

<sup>113</sup> See First Request discussions of the lack of successful commercial experience of sodium-cooled reactors like the ARC-100, pgs 3, 8, 9, 11 and 12

<sup>114</sup> *IAA*, s 6(1)(a)

<sup>115</sup> See First Request discussion on pgs 13, 14, 24 and 27, as well as in the support letter included by the Passamaquoddy Recognition Group representing the Peskotomuhkati Nation at Skutik

<sup>116</sup> Impact Assessment Agency of Canada, “Impact Assessment Process Overview,” (2022) online: <https://www.canada.ca/en/impact-assessment-agency/services/policy-guidance/impact-assessment-process-overview.html>

processes, many of the procedural safeguards are at the discretion of the Minister and occur too late in the process to allow for effective public input.

The application of IA to SMRs would also remedy many of the concerns about the independence of the decision-maker and transparency deficiencies within the regulatory licensing process. As the independent expert panel tasked with reviewing Canada's EA process found, in the lead up to the Bill C-69 that created the IAA, a "frequently cited concern" among the public was the "perceived lack of independence and neutrality because of the close relationship the NEB [National Energy Board] and CNSC have with the industries they regulate."<sup>117</sup> The same expert panel also commented that participants were concerned that the CNSC, "promote[s] the projects they are tasked with regulating" and often used the term "regulatory capture" in describing their perception.<sup>118</sup>

Fundamental to meaningful public participation and additionally, adherence with the precautionary principle, is openness and transparency between the public and decision-makers. We fear however, that given enhanced concerns about security and proliferation associated with the planned activities at the Point Lepreau site, limited information will be made available to the public. The CNSC and proponents frequently choose not to disclose information to the public, and nuclear licensing processes are already prone to secretive behaviour.<sup>119</sup>

The heightened security risks involved with the ARC-100 design's planned use of HALEU fuel and its alternatives, and especially with its plans for plutonium reprocessing, will necessarily lead to increased secrecy surrounding the project. Increased secrecy will mean reduced transparency and less information that can be shared, which will make it even more difficult for the public to make informed decisions about the project.

Given the significant and potentially irreversible risks posed by the construction of this new reactor, decisions must not be rushed or taken lightly. These decisions are of the most profound kind - affecting generations yet to be born. The public must be given an opportunity to look in great depth at statements made by the proponent and the veracity of the information they, and the SMR vendor, are sharing with the public. Impact assessment regimes can significantly vary in their level of complexity and sophistication, and we submit the Agency erred in finding the provincial EIA process would be an adequate substitute without first comparing whether it provides a genuine opportunity to influence decisions, and promote and sustain fair, open and two-way dialogue.

---

<sup>117</sup> Expert Panel Report, "Building Common Ground: A New Vision for Impact Assessment in Canada – The Final Report of the Expert Panel for the Review of the Environmental Assessment Processes," (2017), online: <https://www.canada.ca/content/dam/themes/environment/conservation/environmental-reviews/building-common-ground/building-common-ground.pdf>, p 49 [IA Expert Panel Report]

<sup>118</sup> IA Expert Panel Report, p 49

<sup>119</sup> S-P Stensil, "Politics over Precaution: Canada's approach to new nuclear stations," (June 2008), online: <https://iaac-aeic.gc.ca/050/documents/27768/27768e.pdf>, p 38

## V. PUBLIC CONCERN ALONE MERITS DESIGNATION OF THE PROJECT

It is our view that the high level of public concern for this project merits its designation for an IA, in keeping with subsection 9(1) of the *IAA* that sets out that on the basis of public concern alone, designation can be warranted.

Since the first request was submitted to the Minister in July 2022, public concern has grown significantly about the ARC-100 project. The high public interest value precipitated the Legislative Assembly of New Brunswick Standing Committee holding a two-day hearing on SMRs in early 2023. CBC radio and CBC online, Global TV and other national media outlets have increased their coverage of the topic as well, in response to the high public interest in SMRs.

Since July 2022, when **CRED-NB** submitted the first request to the Minister,

- The number of “CRED-NB Champions” who list their names as supporters on our website has gone up 14%, and donations from the public have increased to support our work
- The CRED-NB website monthly visitor total is more than 5,700 unique users
- The first request to the Minister has been downloaded more than 800 times from the CRED-NB website
- CRED-NB’s most popular post on Facebook about SMRs has to date been shared more than 1,300 times
- CRED-NB was invited to testify about SMRs to the New Brunswick Legislature’s Standing Committee on Climate Change and Environmental Stewardship
- Core CRED-NB members published more than a dozen commentaries about SMRs in local and national media as well as had numerous letters to the editor published
- CRED-NB spokespersons were interviewed more than a dozen times about SMRs for print media and regional TV networks and invited as guests on six regional and national radio programs
- CRED-NB co-sponsored three national webinars on SMRs at which more than 200 people registered
- CRED-NB members were invited to give three presentations about SMRs to university students and one public presentation
- CRED-NB submitted three briefs to House of Commons Standing Committees on topics related to SMRs

There is also significant and demonstrated public concern about radioactive waste disposal from potential host communities in Ontario.

Since its formation in 2020, **We the Nuclear Free North** has:

- Directly distributed information about the proposed deep geological repository to over 60,000 households



- Held numerous public and online forums to share information about the NWMO's project and related environmental and other concerns
- Participated on multiple occasions in forums convened by the City of Dryden to share information and a critique of the NWMO's project;
- Interacted directly with the NWMO on numerous occasions, including during a site visit requested by We the Nuclear Free North to the NWMO drilling locations in the Revell area
- Built and maintained a website for the purposes of providing reliable information about the NWMO's project and linking to additional information sites operated by Environment North and Northwatch;
- Provided the public with information through displays and literature tables at many community events, including at farmers' markets, fall fairs, fishing derbies, and other events.

Concern about the DGR project at the Revell Lake site is also evidenced by:

- An online petition that has collected over 12,000 signatures and a more recent hard-copy petition directed to the Government of Ontario which is still in the signature-collection stage but has to date collected approximately 2,000 signatures<sup>120</sup>
- The formation of several local groups opposing the DGR project
- Frequent letters to the editor by local citizens
- Broad participation in local awareness-raising walks and rallies in Thunder Bay, Ignace, Dryden and Sioux Lookout and along the connecting route between Ignace, Dryden and Sioux Lookout

**Protect our Waterways** mission has been to ensure a life changing event does not occur without the voice of residents being heard. We have collectively devoted thousands of hours to achieving this objective and to also ensure that the lifestyle of our community is protected and that the rich environment nature has given the community will be available for us and our future generations.

We have also:

- Created an online petition against hosting a DGR in South Bruce, which has over 15,000 signatures; we also have two paper petitions circulating, one with 1500 signatures stating no DGR is wanted in our community; the other with 1764 signatures requesting our council commit to hold a referendum to determine the willingness of the residents, for the NWMO project
- Presented our view and concerns about the NWMO to 10 of our neighbouring municipalities Councils
- Delivered 58,000 pamphlets to the households in the surrounding communities; we also mail by-monthly newsletters to all the households in South Bruce sharing news about the project
- Presented to the South Bruce council on 3 separate intervals and have attended all South Bruce Council meetings since 2020

---

<sup>120</sup> Change.org, "Stop the Disposal of Nuclear Waste in Northwestern Ontario," online: <https://www.change.org/p/stop-the-disposal-of-nuclear-waste-in-northwestern-ontario>

- Held two separate car rallies involving more than a 100 vehicles passing through the towns of Teeswater, Mildmay and Formosa to raise the awareness of the project
- Created and maintain a website and Facebook page to give residents the ability to find the latest information about the project that is not being published by the NWMO or our municipality
- Hosted numerous webinars in collaboration with other civil society groups, featuring knowledgeable experts
- Maintain an active in the media, with frequent letters to editor of our local newspapers and appearances on local TV and radio
- Endorsed Congressman Kildee and other politicians' resolution requesting President Biden to take action in protecting the Great Lakes basin, the source of drinking water for 40 million people.

## VI. CONCLUSION

Public concern regarding the project should be respected and the SMR project, including ancillary projects and activities such as reprocessing, waste storage, transportation and disposal, and its proposed use for international trade purpose, ought to be designated for an IA. There remain significant and outstanding concerns about the project's long-term impacts to culture, community, environment and health that cannot be remedied through existing legislative mechanisms.

A duty of fairness is owed to all affected communities whose rights and interests stand to be directly affected and strongest of procedural rights, and meaningful public participation required in the circumstance. Not having an IA impedes communities' right to know and to be heard, and prejudices public participation; as we have detailed above, a CNSC licensing hearing and provincial EIA based in New Brunswick is not a sufficient nor equivalent alternative to a federal IA.

We ask that the Minister order the SMR project be designated for an impact assessment and also, seek a new decision from the Agency and Minister in light of:

1. The material changes to the project since the first request was submitted such that adverse effects in areas of federal jurisdiction that the Agency previously concluded would be mitigated by other legislative mechanisms are no longer valid;
2. The significant errors of fact and law made by the Agency in its analysis about the project upon which the Minister of Environment and Climate Change relied, regarding adverse effects, the treatment of the project's fuel waste, and constitutionally protected Indigenous rights;
3. The failure of the Agency and Minister to consider a number of significant adverse effects in areas of federal jurisdiction, including changes to the environment in another province and outside of Canada; and

4. The failure of the Agency and Minister to have regard to core purposes of the *IAA*, including the promotion of cooperation and coordination among provincial and federal governments, the application of the precautionary principle, the fostering of sustainability, and commitments to meaningful public participation.

Sincerely,

Gretchen Fitzgerald, Sierra Club Canada Foundation on behalf of:

Brennain Lloyd, We the Nuclear Free North

Bill Noll, Protect Our Waterways

Susan O'Donnell, Coalition for Responsible Energy Development in New Brunswick

## Appendix A: Access to Information Release

### Sabo,Ashley (IAAC/AEIC)

---

**From:** Virtue,Robyn-Lynne (IAAC/AEIC)  
**Sent:** July 13, 2022 3:56 PM  
**To:** Kwamena, Nana-Owusua; Harpell, Heather  
**Cc:** Spagnuolo,Colette (IAAC/AEIC); Adams,Jill (IAAC/AEIC); Atkinson,Mike (IAAC/AEIC); Benjamin,Cheryl (IAAC/AEIC); Vigder,Joseph (IAAC/AEIC); Primeau,Eric (IAAC/AEIC)  
**Subject:** RE: Receipt of a Designation Request for a SMR projects at Point Lepreau - NB Power

PROTECTED A - PROTÉGÉ A

Hi Nana,

We will definitely work within the timeslots that you provided and agree that Heather should be there for the discussion. We will talk amongst ourselves at the Agency and then send out a meeting invite to you and Heather for either the 19<sup>th</sup> or 20<sup>th</sup>.

Thanks,

Robyn

**From:** Kwamena, Nana-Owusua <Nana-Owusua.Kwamena@cnsccsn.gc.ca>  
**Sent:** July 13, 2022 2:39 PM  
**To:** Virtue,Robyn-Lynne (IAAC/AEIC) <Robyn-Lynne.Virtue@iaac-aeic.gc.ca>; Harpell, Heather <Heather.harpell@cnsccsn.gc.ca>  
**Cc:** Spagnuolo,Colette (IAAC/AEIC) <Colette.Spagnuolo@iaac-aeic.gc.ca>; Adams,Jill (IAAC/AEIC) <Jill.Adams@iaac-aeic.gc.ca>; Atkinson,Mike (IAAC/AEIC) <Mike.Atkinson@iaac-aeic.gc.ca>; Benjamin,Cheryl (IAAC/AEIC) <Cheryl.Benjamin@iaac-aeic.gc.ca>; Vigder,Joseph (IAAC/AEIC) <joseph.vigder@iaac-aeic.gc.ca>  
**Subject:** RE: Receipt of a Designation Request for a SMR projects at Point Lepreau - NB Power

Hi Robyn,

Heather is out of the office this week and I would like her to be part of the discussion if possible. Additionally, I am out of the office on Friday, July 15.

Could we work to set something up for sometime early next week? Based on availabilities on our end some potential times that may work:

- Tuesday, July 19 – 10-11 am or 1-2 pm
- Wednesday, July 20 – 10-11 am or 2-3 pm

If we need to meet more urgently we could set something up for Monday, July 18<sup>th</sup>, however, I would like to have someone (Sean Belyea) from the licensing division present for meeting and he is unavailable that day.

Hopefully one of those times works with everyone's schedules. In the meantime, if you need any information, please don't hesitate to reach out.

Thanks,  
Nana

*Nana Kwamena* (she, her, elle)

Director, EAD | Directrice, DEE

[nana-owusua.kwamena@cnsccsn.gc.ca](mailto:nana-owusua.kwamena@cnsccsn.gc.ca) | Tel: 343-543-6760

**From:** Virtue, Robyn-Lynne (IAAC/AEIC) <[Robyn-Lynne.Virtue@iaac-aeic.gc.ca](mailto:Robyn-Lynne.Virtue@iaac-aeic.gc.ca)>

**Sent:** Wednesday, July 13, 2022 1:39 PM

**To:** Kwamena, Nana-Owusua <[Nana-Owusua.Kwamena@cnsccsn.gc.ca](mailto:Nana-Owusua.Kwamena@cnsccsn.gc.ca)>; Harpell, Heather <[Heather.Harpell@cnsccsn.gc.ca](mailto:Heather.Harpell@cnsccsn.gc.ca)>

**Cc:** Spagnuolo, Colette (IAAC/AEIC) <[Colette.Spagnuolo@iaac-aeic.gc.ca](mailto:Colette.Spagnuolo@iaac-aeic.gc.ca)>; Adams, Jill (IAAC/AEIC) <[Jill.Adams@iaac-aeic.gc.ca](mailto:Jill.Adams@iaac-aeic.gc.ca)>; Atkinson, Mike (IAAC/AEIC) <[Mike.Atkinson@iaac-aeic.gc.ca](mailto:Mike.Atkinson@iaac-aeic.gc.ca)>; Benjamin, Cheryl (IAAC/AEIC) <[Cheryl.Benjamin@iaac-aeic.gc.ca](mailto:Cheryl.Benjamin@iaac-aeic.gc.ca)>; Vigder, Joseph (IAAC/AEIC) <[joseph.vigder@iaac-aeic.gc.ca](mailto:joseph.vigder@iaac-aeic.gc.ca)>

**Subject:** RE: Receipt of a Designation Request for a SMR projects at Point Lepreau - NB Power

---

EXTERNAL EMAIL – USE CAUTION / COURRIEL EXTERNE – FAITES PREUVE DE PRUDENCE

---

PROTECTED A - PROTÉGÉ A

Hi Nana,

Given schedules with the CNSC, do you have a particular time in mind on your end to have a quick chat?

Thanks, Robyn

**From:** Kwamena, Nana-Owusua <[Nana-Owusua.Kwamena@cnsccsn.gc.ca](mailto:Nana-Owusua.Kwamena@cnsccsn.gc.ca)>

**Sent:** July 12, 2022 4:03 PM

**To:** Virtue, Robyn-Lynne (IAAC/AEIC) <[Robyn-Lynne.Virtue@iaac-aeic.gc.ca](mailto:Robyn-Lynne.Virtue@iaac-aeic.gc.ca)>; Harpell, Heather <[Heather.harpell@cnsccsn.gc.ca](mailto:Heather.harpell@cnsccsn.gc.ca)>

**Cc:** Spagnuolo, Colette (IAAC/AEIC) <[Colette.Spagnuolo@iaac-aeic.gc.ca](mailto:Colette.Spagnuolo@iaac-aeic.gc.ca)>; Adams, Jill (IAAC/AEIC) <[Jill.Adams@iaac-aeic.gc.ca](mailto:Jill.Adams@iaac-aeic.gc.ca)>; Atkinson, Mike (IAAC/AEIC) <[Mike.Atkinson@iaac-aeic.gc.ca](mailto:Mike.Atkinson@iaac-aeic.gc.ca)>; Benjamin, Cheryl (IAAC/AEIC) <[Cheryl.Benjamin@iaac-aeic.gc.ca](mailto:Cheryl.Benjamin@iaac-aeic.gc.ca)>; Vigder, Joseph (IAAC/AEIC) <[joseph.vigder@iaac-aeic.gc.ca](mailto:joseph.vigder@iaac-aeic.gc.ca)>

**Subject:** RE: Receipt of a Designation Request for a SMR projects at Point Lepreau - NB Power

Hello Robyn,

Thanks for reaching out and letting us know about this request. We were also informed about this request through other channels.

As always, we are available to provide either project or licensing information to help inform the response back to the requestors.

Of note, we do have some upcoming leaves in the next week or so. Therefore, it maybe helpful to initially touch base, if possible, to ensure you have the names of CNSC contacts and/or a path forward for obtaining the information you need to respond to this request.

Please don't hesitate to reach out if you have any questions or comments.

Thanks,  
Nana

*Nana Kwamena* (she, her, elle)

Director, EAD | Directrice, DEE

[nana-owusua.kwamena@cnsccsn.gc.ca](mailto:nana-owusua.kwamena@cnsccsn.gc.ca) | Tel: 343-543-6760

**From:** Virtue,Robyn-Lynne (IAAC/AEIC) <[Robyn-Lynne.Virtue@iaac-aeic.gc.ca](mailto:Robyn-Lynne.Virtue@iaac-aeic.gc.ca)>

**Sent:** Tuesday, July 12, 2022 3:11 PM

**To:** Harpell, Heather <[Heather.Harpell@cnsccsn.gc.ca](mailto:Heather.Harpell@cnsccsn.gc.ca)>; Kwamena, Nana-Owusua <[Nana-Owusua.Kwamena@cnsccsn.gc.ca](mailto:Nana-Owusua.Kwamena@cnsccsn.gc.ca)>

**Cc:** Spagnuolo,Colette (IAAC/AEIC) <[Colette.Spagnuolo@iaac-aeic.gc.ca](mailto:Colette.Spagnuolo@iaac-aeic.gc.ca)>; Adams,Jill (IAAC/AEIC) <[Jill.Adams@iaac-aeic.gc.ca](mailto:Jill.Adams@iaac-aeic.gc.ca)>; Atkinson,Mike (IAAC/AEIC) <[Mike.Atkinson@iaac-aeic.gc.ca](mailto:Mike.Atkinson@iaac-aeic.gc.ca)>; Benjamin,Cheryl (IAAC/AEIC) <[Cheryl.Benjamin@iaac-aeic.gc.ca](mailto:Cheryl.Benjamin@iaac-aeic.gc.ca)>; Vigder,Joseph (IAAC/AEIC) <[joseph.vigder@iaac-aeic.gc.ca](mailto:joseph.vigder@iaac-aeic.gc.ca)>

**Subject:** Receipt of a Designation Request for a SMR projects at Point Lepreau - NB Power

---

EXTERNAL EMAIL – USE CAUTION / COURRIEL EXTERNE – FAITES PREUVE DE PRUDENCE

---

PROTECTED A - PROTÉGÉ A

Hi Heather and Nana,

The Minister has received a designation request for the proposed SMR projects by NB Power on the Point Lepreau Nuclear Generating Site. We are currently determining what type of response and will keep you updated on this file. The Minister has 90 days to respond to this request. We may look to the CNSC for some project and licencing information support in the coming weeks.

Kind regards,  
Robyn

*Robyn-Lynne*

Robyn-Lynne Virtue

Panel Manager, Review Panels Division  
Impact Assessment Agency of Canada / Government of Canada  
[Robyn-Lynne.Virtue@iaac-acic.gc.ca](mailto:Robyn-Lynne.Virtue@iaac-acic.gc.ca) / Tel: 613-894-4123

Direction des commissions d'examen  
Agence d'évaluation d'impact du Canada / Gouvernement du Canada  
[robyn-lynn.virtue@acic-iaac.gc.ca](mailto:robyn-lynn.virtue@acic-iaac.gc.ca) / Tél. : 613-894-4123

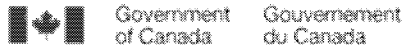

Canada

## Sabo,Ashley (IAAC/AEIC)

---

**From:** Adams,Jill (IAAC/AEIC)  
**Sent:** July 13, 2022 2:47 PM  
**To:** Kwamena, Nana-Owusua; Virtue,Robyn-Lynne (IAAC/AEIC); Harpell, Heather  
**Cc:** Spagnuolo,Colette (IAAC/AEIC); Atkinson,Mike (IAAC/AEIC); Benjamin,Cheryl (IAAC/AEIC); Vigder,Joseph (IAAC/AEIC)  
**Subject:** RE: Receipt of a Designation Request for a SMR projects at Point Lepreau - NB Power

PROTECTED A - PROTÉGÉ A

Hi there,  
I am available Tuesday 10-11 EST. I am off Wed-Fri of next week.  
Thanks,  
Jill

Jill Adams (She/Her/Elle)

Head, Newfoundland and Labrador Satellite Office  
Impact Assessment Agency of Canada  
[jill.adams@iaac-aeic.gc.ca](mailto:jill.adams@iaac-aeic.gc.ca) / Tel: 709-330-6297

Chef, Bureau satellite de Terre-Neuve-et-Labrador  
Agence d'évaluation d'impact du Canada  
[jill.adams@iaac-aeic.gc.ca](mailto:jill.adams@iaac-aeic.gc.ca) / Tel: 709-330-6297



Canada

**From:** Kwamena, Nana-Owusua <Nana-Owusua.Kwamena@cnsccsn.gc.ca>  
**Sent:** Wednesday, July 13, 2022 4:09 PM  
**To:** Virtue,Robyn-Lynne (IAAC/AEIC) <Robyn-Lynne.Virtue@iaac-aeic.gc.ca>; Harpell, Heather <Heather.harpell@cnsccsn.gc.ca>  
**Cc:** Spagnuolo,Colette (IAAC/AEIC) <Colette.Spagnuolo@iaac-aeic.gc.ca>; Adams,Jill (IAAC/AEIC) <Jill.Adams@iaac-aeic.gc.ca>; Atkinson,Mike (IAAC/AEIC) <Mike.Atkinson@iaac-aeic.gc.ca>; Benjamin,Cheryl (IAAC/AEIC) <Cheryl.Benjamin@iaac-aeic.gc.ca>; Vigder,Joseph (IAAC/AEIC) <joseph.vigder@iaac-aeic.gc.ca>  
**Subject:** RE: Receipt of a Designation Request for a SMR projects at Point Lepreau - NB Power

Hi Robyn,

Heather is out of the office this week and I would like her to be part of the discussion if possible. Additionally, I am out of the office on Friday, July 15.



Could we work to set something up for sometime early next week? Based on availabilities on our end some potential times that may work:

- Tuesday, July 19 – 10-11 am or 1-2 pm
- Wednesday, July 20 – 10-11 am or 2-3 pm

If we need to meet more urgently we could set something up for Monday, July 18<sup>th</sup>, however, I would like to have someone (Sean Belyea) from the licensing division present for meeting and he is unavailable that day.

Hopefully one of those times works with everyone's schedules. In the meantime, if you need any information, please don't hesitate to reach out.

Thanks,  
Nana

*Nana Kwamena* (she, her, elle)

Director, EAD | Directrice, DEE

[nana-owusua.kwamena@cnsccsn.gc.ca](mailto:nana-owusua.kwamena@cnsccsn.gc.ca) | Tel: 343-543-6760

**From:** Virtue,Robyn-Lynne (IAAC/AEIC) <[Robyn-Lynne.Virtue@iaac-aeic.gc.ca](mailto:Robyn-Lynne.Virtue@iaac-aeic.gc.ca)>

**Sent:** Wednesday, July 13, 2022 1:39 PM

**To:** Kwamena, Nana-Owusua <[Nana-Owusua.Kwamena@cnsccsn.gc.ca](mailto:Nana-Owusua.Kwamena@cnsccsn.gc.ca)>; Harpell, Heather <[Heather.Harpell@cnsccsn.gc.ca](mailto:Heather.Harpell@cnsccsn.gc.ca)>

**Cc:** Spagnuolo,Colette (IAAC/AEIC) <[Colette.Spagnuolo@iaac-aeic.gc.ca](mailto:Colette.Spagnuolo@iaac-aeic.gc.ca)>; Adams,Jill (IAAC/AEIC) <[Jill.Adams@iaac-aeic.gc.ca](mailto:Jill.Adams@iaac-aeic.gc.ca)>; Atkinson,Mike (IAAC/AEIC) <[Mike.Atkinson@iaac-aeic.gc.ca](mailto:Mike.Atkinson@iaac-aeic.gc.ca)>; Benjamin,Cheryl (IAAC/AEIC) <[Cheryl.Benjamin@iaac-aeic.gc.ca](mailto:Cheryl.Benjamin@iaac-aeic.gc.ca)>; Vigder,Joseph (IAAC/AEIC) <[joseph.vigder@iaac-aeic.gc.ca](mailto:joseph.vigder@iaac-aeic.gc.ca)>

**Subject:** RE: Receipt of a Designation Request for a SMR projects at Point Lepreau - NB Power

EXTERNAL EMAIL – USE CAUTION / COURRIEL EXTERNE – FAITES PREUVE DE PRUDENCE

PROTECTED A - PROTÉGÉ A

Hi Nana,

Given schedules with the CNSC, do you have a particular time in mind on your end to have a quick chat?

Thanks, Robyn

**From:** Kwamena, Nana-Owusua <[Nana-Owusua.Kwamena@cnsccsn.gc.ca](mailto:Nana-Owusua.Kwamena@cnsccsn.gc.ca)>

**Sent:** July 12, 2022 4:03 PM

**To:** Virtue,Robyn-Lynne (IAAC/AEIC) <[Robyn-Lynne.Virtue@iaac-aeic.gc.ca](mailto:Robyn-Lynne.Virtue@iaac-aeic.gc.ca)>; Harpell, Heather <[Heather.harpell@cnsccsn.gc.ca](mailto:Heather.harpell@cnsccsn.gc.ca)>

**Cc:** Spagnuolo,Colette (IAAC/AEIC) <[Colette.Spagnuolo@iaac-aeic.gc.ca](mailto:Colette.Spagnuolo@iaac-aeic.gc.ca)>; Adams,Jill (IAAC/AEIC) <[Jill.Adams@iaac-aeic.gc.ca](mailto:Jill.Adams@iaac-aeic.gc.ca)>; Atkinson,Mike (IAAC/AEIC)

<Mike.Atkinson@iaac-aeic.gc.ca>; Benjamin,Cheryl (IAAC/AEIC) <Cheryl.Benjamin@iaac-aeic.gc.ca>; Vigder,Joseph (IAAC/AEIC) <joseph.vigder@iaac-aeic.gc.ca>

**Subject:** RE: Receipt of a Designation Request for a SMR projects at Point Lepreau - NB Power

Hello Robyn,

Thanks for reaching out and letting us know about this request. We were also informed about this request through other channels.

As always, we are available to provide either project or licensing information to help inform the response back to the requestors.

Of note, we do have some upcoming leaves in the next week or so. Therefore, it maybe helpful to initially touch base, if possible, to ensure you have the names of CNSC contacts and/or a path forward for obtaining the information you need to respond to this request.

Please don't hesitate to reach out if you have any questions or comments.

Thanks,

Nana

*Nana Kwamena* (she, her, elle)

Director, EAD | Directrice, DEE

[nana-owusua.kwamena@cnscccsn.gc.ca](mailto:nana-owusua.kwamena@cnscccsn.gc.ca) | Tel: 343-543-6760

**From:** Virtue,Robyn-Lynne (IAAC/AEIC) <Robyn-Lynne.Virtue@iaac-aeic.gc.ca>

**Sent:** Tuesday, July 12, 2022 3:11 PM

**To:** Harpell, Heather <Heather.Harpell@cnscccsn.gc.ca>; Kwamena, Nana-Owusua <Nana-Owusua.Kwamena@cnscccsn.gc.ca>

**Cc:** Spagnuolo,Colette (IAAC/AEIC) <Colette.Spagnuolo@iaac-aeic.gc.ca>; Adams,Jill (IAAC/AEIC) <Jill.Adams@iaac-aeic.gc.ca>; Atkinson,Mike (IAAC/AEIC)

<Mike.Atkinson@iaac-aeic.gc.ca>; Benjamin,Cheryl (IAAC/AEIC) <Cheryl.Benjamin@iaac-aeic.gc.ca>; Vigder,Joseph (IAAC/AEIC) <joseph.vigder@iaac-aeic.gc.ca>

**Subject:** Receipt of a Designation Request for a SMR projects at Point Lepreau - NB Power

---

EXTERNAL EMAIL – USE CAUTION / COURRIEL EXTERNE – FAITES PREUVE DE PRUDENCE

---

PROTECTED A - PROTÉGÉ A

Hi Heather and Nana,

The Minister has received a designation request for the proposed SMR projects by NB Power on the Point Lepreau Nuclear Generating Site. We are currently determining what type of response and will keep you updated on this file. The Minister has 90 days to respond to this request. We may look to the CNSC for some project and licencing information support in the coming weeks.

Kind regards,  
Robyn

*Robyn-Lynne*

Robyn-Lynne Virtue  
Panel Manager, Review Panels Division  
Impact Assessment Agency of Canada / Government of Canada  
[Robyn-Lynne.Virtue@iaac-acic.gc.ca](mailto:Robyn-Lynne.Virtue@iaac-acic.gc.ca) / Tel: 613-894-4123

Direction des commissions d'examen  
Agence d'évaluation d'impact du Canada / Gouvernement du Canada  
[robyn-lynn.virtue@acic-iaac.gc.ca](mailto:robyn-lynn.virtue@acic-iaac.gc.ca) / Tél. : 613-894-4123

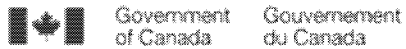

Canada

**Sabo,Ashley (IAAC/AEIC)**

---

**From:** Adams,Jill (IAAC/AEIC)  
**Sent:** July 13, 2022 4:31 PM  
**To:** Virtue,Robyn-Lynne (IAAC/AEIC)  
**Subject:** Accepted: Discussion on Designation Request of NB Power SMR Projects

**Sabo,Ashley (IAAC/AEIC)**

---

**From:** Adams,Jill (IAAC/AEIC)  
**Sent:** July 13, 2022 2:45 PM  
**To:** Atkinson,Mike (IAAC/AEIC)  
**Subject:** Accepted: SMR DR

Meeting w NB Power

Date

- SMR Action Plan
- NB Economic Feasibility Stud
  - Cross-Canada SMR feasibility study
- ARC ready for commercial deployment in ~2030s
- Funding from who?
  - NB Power I assume is landing agreement etc. w vendors as tech support
- Funding received from prov gov.
- Molter received \$0 mil; NB Power received amount for research
- Info needed on waste streams
- Plan to apply for "licence to prepare site"  
in June 2023
- Plan for licence to construction Dec 2024
- ~~SMR~~ Only plans currently for 1 ARC-100  
SMR

- Still looking for investors

- Main investor will likely become proponent
- NB Power will be licensee (and likely proponent, but could be main investor)

Page

### Meeting with CNSC

- Project updates/status
  - Determining (1) if it's on Pay List & (2) 2 projects of 1
- CNSC has not received any application
  - NB Power
  - ARC is further ahead
    - licensing application in ~ 1 year (generous)
    - Plan 1 ARC register currently, could involve more
- Heard from NB Env. that Proponent may ~~come~~ register soon

- Proponent is working on env. review info

- Timing
  - Parallel CNSC licensing & IS review (June 2023)
    - Need 6 months for planning phase before

- NB Power definitely licensee (aka proponent) / applicant for both SMRs
  - ARC vs. Molten separate licenses, different timing
  - Molten further away

- Want to conduct design review



- Can't make designation until clarity is provided around project itself

- Consider 1 vs 2 projects?

- Ensure no project splitting

- MITA still required if we go back to Phase 1  
Requester saying not enough info to designate

- CNSC review process

- Env. review process under Nuclear Safety Act

- CNSC document released for public review

- Project descriptions being requested

- from proponents (similar to EA process)

- Involve other EAs & province

- CNSC would participate in prov. EA process

- Sean Bezyea main contact for rest of summer at CNSC

\* - Case for Strategic IA?

## Sabo,Ashley (IAAC/AEIC)

---

**From:** Gauthier, Rick <RGauthier@nbpower.com>  
**Sent:** July 26, 2022 7:02 AM  
**To:** Vigder,Joseph (IAAC/AEIC)  
**Subject:** RE: EXT - RE: NB Power Contact - SMR Demonstration Project

**Categories:** For ATIP, Filed to GCDocs

Thanks again Joe, we will be prepared to update you and your team on the items below.



Rick Gauthier  
*Licensing Manager*  
*Advanced Reactor Development Team*  
506.651.3286  
nbpower.com | energienb.com

**From:** Vigder,Joseph (IAAC/AEIC) <joseph.vigder@iaac-aeic.gc.ca>  
**Sent:** July 25, 2022 3:44 PM  
**To:** Gauthier, Rick <RGauthier@nbpower.com>  
**Subject:** RE: EXT - RE: NB Power Contact - SMR Demonstration Project

Hi Rick,

I just wanted to provide a bit of additional context regarding the designation request the Minister has received in preparation for the meeting on Thursday. The requestor has asked the Minister to consider the potentially proposed ARC SMR(s) and Moltex SMR as a single project and designate it for federal impact assessment under the Impact Assessment Act.

Among other information that NP Power is able to provide, the Agency would be interested in hearing about the status of these two potential SMRs, the relationships between them, NB Power, and the vendors; as well as any plans for licensing, approvals, or impact/environmental review for each.

Again, if you would like any additional information to help prepare for the discussion, or if there are specific items you would like to hear about from us, don't hesitate to reach out.

Thanks,  
Joe

**From:** Gauthier, Rick <[RGauthier@nbpower.com](mailto:RGauthier@nbpower.com)>  
**Sent:** July 25, 2022 7:36 AM  
**To:** Vigder, Joseph (IAAC/AEIC) <[joseph.vigder@iaac-aeic.gc.ca](mailto:joseph.vigder@iaac-aeic.gc.ca)>  
**Cc:** Adams, Jill (IAAC/AEIC) <[Jill.Adams@iaac-aeic.gc.ca](mailto:Jill.Adams@iaac-aeic.gc.ca)>; Belland, Brenna (IAAC/AEIC) <[Brenna.Belland@iaac-aeic.gc.ca](mailto:Brenna.Belland@iaac-aeic.gc.ca)>; Primeau, Eric (IAAC/AEIC) <[Eric.Primeau@iaac-aeic.gc.ca](mailto:Eric.Primeau@iaac-aeic.gc.ca)>; Katahwa, Kambale (IAAC/AEIC) <[kambale.katahwa@iaac-aeic.gc.ca](mailto:kambale.katahwa@iaac-aeic.gc.ca)>  
**Subject:** RE: EXT - RE: NB Power Contact - SMR Demonstration Project

Thanks Joe, I have set a calendar notice for a Teams meeting Thursday afternoon.

Should we also invite

Colette Spagnuolo

Director, Review Panels Division

Impact Assessment Agency of Canada / Government of Canada

[colette.spagnuolo@iaac-aeic.gc.ca](mailto:colette.spagnuolo@iaac-aeic.gc.ca) / Cel: 613-282-8245

I can add Colette to the notice if appropriate.



Rick Gauthier  
*Licensing Manager*  
*Advanced Reactor Development Team*  
506.651.3286  
[nbpower.com](http://nbpower.com) | [energienb.com](http://energienb.com)

**From:** Vigder, Joseph (IAAC/AEIC) <[joseph.vigder@iaac-aeic.gc.ca](mailto:joseph.vigder@iaac-aeic.gc.ca)>  
**Sent:** July 22, 2022 11:07 AM  
**To:** Gauthier, Rick <[RGauthier@nbpower.com](mailto:RGauthier@nbpower.com)>  
**Cc:** Adams, Jill (IAAC/AEIC) <[Jill.Adams@iaac-aeic.gc.ca](mailto:Jill.Adams@iaac-aeic.gc.ca)>; Belland, Brenna (IAAC/AEIC) <[Brenna.Belland@iaac-aeic.gc.ca](mailto:Brenna.Belland@iaac-aeic.gc.ca)>; Primeau, Eric (IAAC/AEIC) <[Eric.Primeau@iaac-aeic.gc.ca](mailto:Eric.Primeau@iaac-aeic.gc.ca)>; Katahwa, Kambale (IAAC/AEIC) <[kambale.katahwa@iaac-aeic.gc.ca](mailto:kambale.katahwa@iaac-aeic.gc.ca)>  
**Subject:** RE: EXT - RE: NB Power Contact - SMR Demonstration Project

Hi Rick,

It looks like the afternoon of Thursday, July 28<sup>th</sup> works best on our end for a meeting. Anytime after 2:30pm Atlantic (1:30pm Eastern) is fine. Please send the invite to myself as well as the following folks from the Agency (all cc'ed): Jill Adams, Brenna Belland, Eric Primeau, and Kambale Katahwa.

Beyond general introductions, we are interested in hearing from NB Power regarding its current and future plans for SMRs at the Point Lepreau facility.

It will also be an opportunity for us to provide some information regarding the designation process under the *Impact Assessment Act*, as well as other requirements under the Act and its potential application to any new SMRs. I did not plan on preparing any formal presentations or develop a formal agenda, but if there are specific items you would like to discuss, let me know and I can prepare accordingly.

If you have any questions before the meeting, don't hesitate to reach out.

Have a good weekend,

Joe

**From:** Gauthier, Rick <[RGauthier@nbpower.com](mailto:RGauthier@nbpower.com)>  
**Sent:** July 21, 2022 12:08 PM  
**To:** Vigder, Joseph (IAAC/AEIC) <[joseph.vigder@iaac-aeic.gc.ca](mailto:joseph.vigder@iaac-aeic.gc.ca)>  
**Cc:** Belyea, Sean <[Sean.Belyea@cnsccsn.gc.ca](mailto:Sean.Belyea@cnsccsn.gc.ca)>  
**Subject:** RE: EXT - RE: NB Power Contact - SMR Demonstration Project

Good day Joe and thanks for the email.

Yes we would like the opportunity to have this discussion virtually, if you could provide times that you would be available Thursday or Friday of next week I would be happy to schedule a meeting and invite our team members at NB Power.

I look forward to meeting you.



Rick Gauthier  
*Licensing Manager*  
*Advanced Reactor Development Team*  
506.651.3286  
[nbpower.com](http://nbpower.com) | [energienb.com](http://energienb.com)

**From:** Vigder, Joseph (IAAC/AEIC) <[joseph.vigder@iaac-aeic.gc.ca](mailto:joseph.vigder@iaac-aeic.gc.ca)>  
**Sent:** July 20, 2022 4:19 PM  
**To:** Gauthier, Rick <[RGauthier@nbpower.com](mailto:RGauthier@nbpower.com)>  
**Cc:** Belyea, Sean <[Sean.Belyea@cnsccsn.gc.ca](mailto:Sean.Belyea@cnsccsn.gc.ca)>  
**Subject:** EXT - RE: NB Power Contact - SMR Demonstration Project

\*\*\* Attention: External Message / Message externe \*\*\*

Good afternoon Rick (and thank you Sean for putting us in touch),

For some quick context, the Minister of Environment and Climate Change Canada has recently received a request to designate a proposed Small Modular Reactor (SMR) Demonstration Project at the Point Lepreau Nuclear Station under the *Impact Assessment Act*. We (the Impact Assessment Agency of Canada) are conducting an initial review.

At this point, I am looking for an appropriate contact at NB Power with whom we can work to provide a bit more information regarding the project, or projects, that are being planned. Please let me know if that would be yourself, and if anyone else at NB Power should be involved in any preliminary discussions or correspondence.

If possible, I think it would be worthwhile organizing a meeting in the next week or so where we can sit down (virtually at least) and discuss.

In the meantime, I am definitely available to chat or answer any preliminary questions you may have, so don't hesitate to reach out.

Thank you,

Joe

Joe Vigder  
(he/him | il)

Project Manager, Atlantic Region  
Impact Assessment Agency of Canada / Government of Canada  
[joseph.vigder@iaac-aeic.gc.ca](mailto:joseph.vigder@iaac-aeic.gc.ca) / Tel : 902-229-9637

Gestionnaire de projets, région atlantique  
Agence d'évaluation d'impact du Canada / Gouvernement du Canada  
[joseph.vigder@iaac-aeic.gc.ca](mailto:joseph.vigder@iaac-aeic.gc.ca) / Tél : 902-229-9637

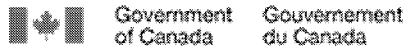

**From:** Belyea, Sean <[Sean.Belyea@cnsccsn.gc.ca](mailto:Sean.Belyea@cnsccsn.gc.ca)>  
**Sent:** July 20, 2022 3:34 PM  
**To:** Vigder, Joseph (IAAC/AEIC) <[joseph.vigder@iaac-aeic.gc.ca](mailto:joseph.vigder@iaac-aeic.gc.ca)>  
**Cc:** Gauthier, Rick <[RGauthier@nbpower.com](mailto:RGauthier@nbpower.com)>  
**Subject:** RE: NB Power Contact - SMR Demonstration Project

Hi Joe,

I'm glad you found the meeting productive. I did as well.

The main contact I have for you at NB Power is Rick Gauthier, who is the Licensing Manager for the Advanced Reactor Development Team. I have copied him on this email.

I'm sure he'd be happy to talk with you about potential plans on the Point Lepreau site, or at the very least put you in contact with the appropriate contact at NB Power.

By all means let me know if I can help further.

Sean Belyea  
Advanced Reactor Licensing Division / Division de l'autorisation des réacteurs avancés  
Canadian Nuclear Safety Commission | Commission canadienne de sûreté nucléaire  
Ottawa, Canada K1P 5S9  
[sean.belyea@cnsccsn.gc.ca](mailto:sean.belyea@cnsccsn.gc.ca) (\*\* Note New Email!)  
Telephone | Téléphone [343-573-8179](tel:343-573-8179) (\*\* Note New Number - Voice and SMS (text) Enabled \*\*)

**From:** Vigder, Joseph (IAAC/AEIC) <[joseph.vigder@iaac-aeic.gc.ca](mailto:joseph.vigder@iaac-aeic.gc.ca)>  
**Sent:** July 20, 2022 1:27 PM  
**To:** Belyea, Sean <[Sean.Belyea@cnsccsn.gc.ca](mailto:Sean.Belyea@cnsccsn.gc.ca)>  
**Subject:** NB Power Contact - SMR Demonstration Project

---

EXTERNAL EMAIL – USE CAUTION / COURRIEL EXTERNE – FAITES PREUVE DE PRUDENCE

---

Hi Sean,

Thanks for all the context and information you shared at the meeting on Tuesday regarding the potential SMR Demonstration projects at Point Lepreau. I found it very helpful.

If possible, could you provide me with a contact(s) at NB Power who I could get in touch with regarding their potential plans? I was hoping to set up a meeting with them to discuss?

Thanks!

Joe Vigder  
(he/him | il)

Project Manager, Atlantic Region  
Impact Assessment Agency of Canada / Government of Canada  
[joseph.vigder@iaac-aeic.gc.ca](mailto:joseph.vigder@iaac-aeic.gc.ca) / Tel : 902-426-4951 / Cell : 902-229-9637

Gestionnaire de projets, région atlantique  
Agence d'évaluation d'impact du Canada / Gouvernement du Canada  
[joseph.vigder@iaac-aeic.gc.ca](mailto:joseph.vigder@iaac-aeic.gc.ca) / Tél : 902-426-4951 / Cel. : 902-229-9637



Canada

---

This e-mail communication (including any or all attachments) is intended only for the use of the person or entity to which it is addressed and may contain confidential and/or privileged material. If you are not the intended recipient of this e-mail, any use, review, retransmission, distribution, dissemination, copying, printing, or other use of, or taking of any action in reliance upon this e-mail, is strictly prohibited. If you have received this e-mail in error, please contact the sender and delete the original and any copy of this e-mail and any printout thereof, immediately. Your co-operation is appreciated.

Le présent courriel (y compris toute pièce jointe) s'adresse uniquement à son destinataire, qu'il soit une personne ou un organisme, et pourrait comporter des renseignements privilégiés ou confidentiels. Si vous n'êtes pas le destinataire du courriel, il est interdit d'utiliser, de revoir, de retransmettre, de distribuer, de disséminer, de copier ou d'imprimer ce courriel, d'agir en vous y fiant ou de vous en servir de toute autre façon. Si vous avez reçu le présent courriel par erreur, prière de communiquer avec l'expéditeur et d'éliminer l'original du courriel, ainsi que toute copie électronique ou imprimée de celui-ci, immédiatement. Nous sommes reconnaissants de votre collaboration.

## Sabo,Ashley (IAAC/AEIC)

---

**From:** Gauthier, Rick <RGauthier@nbpower.com>  
**Sent:** July 25, 2022 8:35 AM  
**To:** Vigder,Joseph (IAAC/AEIC)  
**Cc:** Adams,Jill (IAAC/AEIC); Belland,Brenna (IAAC/AEIC); Primeau,Eric (IAAC/AEIC); Katahwa,Kambale (IAAC/AEIC)  
**Subject:** RE: EXT - RE: NB Power Contact - SMR Demonstration Project

**Categories:** For ATIP, Filed to GCDocs

Thanks Joe



Rick Gauthier  
*Licensing Manager*  
*Advanced Reactor Development Team*  
506.651.3286  
nbpower.com | energienb.com

**From:** Vigder,Joseph (IAAC/AEIC) <joseph.vigder@iaac-aeic.gc.ca>  
**Sent:** July 25, 2022 9:32 AM  
**To:** Gauthier, Rick <RGauthier@nbpower.com>  
**Cc:** Adams,Jill (IAAC/AEIC) <Jill.Adams@iaac-aeic.gc.ca>; Belland,Brenna (IAAC/AEIC) <Brenna.Belland@iaac-aeic.gc.ca>; Primeau,Eric (IAAC/AEIC) <Eric.Primeau@iaac-aeic.gc.ca>; Katahwa,Kambale (IAAC/AEIC) <kambale.katahwa@iaac-aeic.gc.ca>  
**Subject:** RE: EXT - RE: NB Power Contact - SMR Demonstration Project

Hi Rick,

Brenna Belland and Eric Primeau are both from the Agency's Review Panels Division, and can bring their perspective to the discussion. I don't think we need to invite Colette as well.

Thanks,  
Joe

**From:** Gauthier, Rick <RGauthier@nbpower.com>  
**Sent:** July 25, 2022 7:36 AM  
**To:** Vigder,Joseph (IAAC/AEIC) <joseph.vigder@iaac-aeic.gc.ca>  
**Cc:** Adams,Jill (IAAC/AEIC) <Jill.Adams@iaac-aeic.gc.ca>; Belland,Brenna (IAAC/AEIC) <Brenna.Belland@iaac-aeic.gc.ca>; Primeau,Eric (IAAC/AEIC)



<Eric.Primeau@iaac-aeic.gc.ca>; Katahwa,Kambale (IAAC/AEIC) <kambale.katahwa@iaac-aeic.gc.ca>

**Subject:** RE: EXT - RE: NB Power Contact - SMR Demonstration Project

Thanks Joe, I have set a calendar notice for a Teams meeting Thursday afternoon.

Should we also invite

Colette Spagnuolo

Director, Review Panels Division

Impact Assessment Agency of Canada / Government of Canada

[colette.spagnuolo@iaac-aeic.gc.ca](mailto:colette.spagnuolo@iaac-aeic.gc.ca) / Cel: 613-282-8245

I can add Colette to the notice if appropriate.

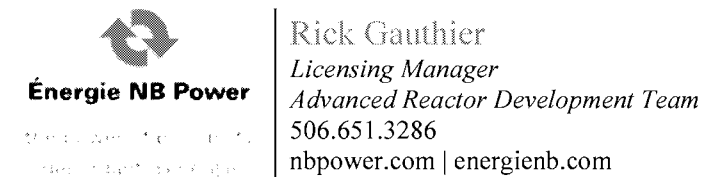

**From:** Vigder,Joseph (IAAC/AEIC) <joseph.vigder@iaac-aeic.gc.ca>

**Sent:** July 22, 2022 11:07 AM

**To:** Gauthier, Rick <RGauthier@nbpower.com>

**Cc:** Adams,Jill (IAAC/AEIC) <Jill.Adams@iaac-aeic.gc.ca>; Belland,Brenna (IAAC/AEIC) <Brenna.Belland@iaac-aeic.gc.ca>; Primeau,Eric (IAAC/AEIC) <Eric.Primeau@iaac-aeic.gc.ca>; Katahwa,Kambale (IAAC/AEIC) <kambale.katahwa@iaac-aeic.gc.ca>

**Subject:** RE: EXT - RE: NB Power Contact - SMR Demonstration Project

Hi Rick,

It looks like the afternoon of Thursday, July 28<sup>th</sup> works best on our end for a meeting. Anytime after 2:30pm Atlantic (1:30pm Eastern) is fine. Please send the invite to myself as well as the following folks from the Agency (all cc'ed): Jill Adams, Brenna Belland, Eric Primeau, and Kambale Katahwa.

Beyond general introductions, we are interested in hearing from NB Power regarding its current and future plans for SMRs at the Point Lepreau facility.

It will also be an opportunity for us to provide some information regarding the designation process under the *Impact Assessment Act*, as well as other requirements under the Act and its potential application to any new SMRs. I did not plan on preparing any formal presentations or develop a formal agenda, but if there are specific items you would like to discuss, let me know and I can prepare accordingly.

If you have any questions before the meeting, don't hesitate to reach out.

Have a good weekend,

Joe

**From:** Gauthier, Rick <[RGauthier@nbpower.com](mailto:RGauthier@nbpower.com)>  
**Sent:** July 21, 2022 12:08 PM  
**To:** Vigder, Joseph (IAAC/AEIC) <[joseph.vigder@iaac-aeic.gc.ca](mailto:joseph.vigder@iaac-aeic.gc.ca)>  
**Cc:** Belyea, Sean <[Sean.Belyea@cnsccsn.gc.ca](mailto:Sean.Belyea@cnsccsn.gc.ca)>  
**Subject:** RE: EXT - RE: NB Power Contact - SMR Demonstration Project

Good day Joe and thanks for the email.

Yes we would like the opportunity to have this discussion virtually, if you could provide times that you would be available Thursday or Friday of next week I would be happy to schedule a meeting and invite our team members at NB Power.

I look forward to meeting you.

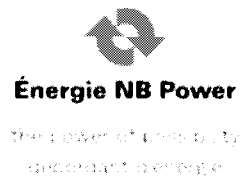

Rick Gauthier  
*Licensing Manager*  
*Advanced Reactor Development Team*  
506.651.3286  
[nbpower.com](http://nbpower.com) | [energienb.com](http://energienb.com)

**From:** Vigder, Joseph (IAAC/AEIC) <[joseph.vigder@iaac-aeic.gc.ca](mailto:joseph.vigder@iaac-aeic.gc.ca)>  
**Sent:** July 20, 2022 4:19 PM  
**To:** Gauthier, Rick <[RGauthier@nbpower.com](mailto:RGauthier@nbpower.com)>  
**Cc:** Belyea, Sean <[Sean.Belyea@cnsccsn.gc.ca](mailto:Sean.Belyea@cnsccsn.gc.ca)>  
**Subject:** EXT - RE: NB Power Contact - SMR Demonstration Project

\*\*\* Attention: External Message / Message externe \*\*\*

Good afternoon Rick (and thank you Sean for putting us in touch),

For some quick context, the Minister of Environment and Climate Change Canada has recently received a request to designate a proposed Small Modular Reactor (SMR) Demonstration Project at the Point Lepreau Nuclear Station under the *Impact Assessment Act*. We (the Impact Assessment Agency of Canada) are conducting an initial review.

At this point, I am looking for an appropriate contact at NB Power with whom we can work to provide a bit more information regarding the project, or projects, that are being planned. Please let me know if that would be yourself, and if anyone else at NB Power should be involved in any preliminary discussions or correspondence.

If possible, I think it would be worthwhile organizing a meeting in the next week or so where we can sit down (virtually at least) and discuss.

In the meantime, I am definitely available to chat or answer any preliminary questions you may have, so don't hesitate to reach out.

Thank you,

Joe

Joe Vigder  
(he/him | il)

Project Manager, Atlantic Region  
Impact Assessment Agency of Canada / Government of Canada  
[joseph.vigder@iaac-aeic.gc.ca](mailto:joseph.vigder@iaac-aeic.gc.ca) / Tel : 902-229-9637

Gestionnaire de projets, région atlantique  
Agence d'évaluation d'impact du Canada / Gouvernement du Canada  
[joseph.vigder@iaac-aeic.gc.ca](mailto:joseph.vigder@iaac-aeic.gc.ca) / Tél : 902-229-9637

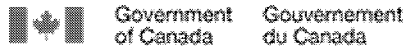

**From:** Belyea, Sean <[Sean.Belyea@cnsccsn.gc.ca](mailto:Sean.Belyea@cnsccsn.gc.ca)>  
**Sent:** July 20, 2022 3:34 PM  
**To:** Vigder, Joseph (IAAC/AEIC) <[joseph.vigder@iaac-aeic.gc.ca](mailto:joseph.vigder@iaac-aeic.gc.ca)>  
**Cc:** Gauthier, Rick <[RGauthier@nbpower.com](mailto:RGauthier@nbpower.com)>  
**Subject:** RE: NB Power Contact - SMR Demonstration Project

Hi Joe,

I'm glad you found the meeting productive. I did as well.

The main contact I have for you at NB Power is Rick Gauthier, who is the Licensing Manager for the Advanced Reactor Development Team. I have copied him on this email.

I'm sure he'd be happy to talk with you about potential plans on the Point Lepreau site, or at the very least put you in contact with the appropriate contact at NB Power.

By all means let me know if I can help further.

Sean Belyea

Advanced Reactor Licensing Division / Division de l'autorisation des réacteurs avancés

Canadian Nuclear Safety Commission | Commission canadienne de sûreté nucléaire

Ottawa, Canada K1P 5S9

[sean.belyea@cnsccsn.gc.ca](mailto:sean.belyea@cnsccsn.gc.ca) (\*\* Note New Email!)

Telephone | Téléphone [343-573-8179](tel:343-573-8179) (\*\* Note New Number - Voice and SMS (text) Enabled \*\*)

**From:** Vigder, Joseph (IAAC/AEIC) <[joseph.vigder@iaac-aeic.gc.ca](mailto:joseph.vigder@iaac-aeic.gc.ca)>

**Sent:** July 20, 2022 1:27 PM

**To:** Belyea, Sean <[Sean.Belyea@cnsccsn.gc.ca](mailto:Sean.Belyea@cnsccsn.gc.ca)>

**Subject:** NB Power Contact - SMR Demonstration Project

---

EXTERNAL EMAIL – USE CAUTION / COURRIEL EXTERNE – FAITES PREUVE DE PRUDENCE

---

Hi Sean,

Thanks for all the context and information you shared at the meeting on Tuesday regarding the potential SMR Demonstration projects at Point Lepreau. I found it very helpful.

If possible, could you provide me with a contact(s) at NB Power who I could get in touch with regarding their potential plans? I was hoping to set up a meeting with them to discuss?

Thanks!

Joe Vigder  
(he/him | il)

Project Manager, Atlantic Region

Impact Assessment Agency of Canada / Government of Canada

[joseph.vigder@iaac-aeic.gc.ca](mailto:joseph.vigder@iaac-aeic.gc.ca) / Tel : 902-426-4951 / Cell : 902-229-9637

---

This e-mail communication (including any or all attachments) is intended only for the use of the person or entity to which it is addressed and may contain confidential and/or privileged material. If you are not the intended recipient of this e-mail, any use, review, retransmission, distribution, dissemination, copying, printing, or other use of, or taking of any action in reliance upon this e-mail, is strictly prohibited. If you have received this e-mail in error, please contact the sender and delete the original and any copy of this e-mail and any printout thereof, immediately. Your co-operation is appreciated.

Le présent courriel (y compris toute pièce jointe) s'adresse uniquement à son destinataire, qu'il soit une personne ou un organisme, et pourrait comporter des renseignements privilégiés ou confidentiels. Si vous n'êtes pas le destinataire du courriel, il est interdit d'utiliser, de revoir, de retransmettre, de distribuer, de disséminer, de copier ou d'imprimer ce courriel, d'agir en vous y fiant ou de vous en servir de toute autre façon. Si vous avez reçu le présent courriel par erreur, prière de communiquer avec l'expéditeur et d'éliminer l'original du courriel, ainsi que toute copie électronique ou imprimée de celui-ci, immédiatement. Nous sommes reconnaissants de votre collaboration.

**Sabo,Ashley (IAAC/AEIC)**

---

**From:** Adams,Jill (IAAC/AEIC)  
**Sent:** July 25, 2022 7:35 AM  
**To:** Gauthier, Rick  
**Subject:** Accepted: SMR Demonstration Project

## Sabo,Ashley (IAAC/AEIC)

---

**Subject:** SMR Demonstration Project  
**Location:** Microsoft Teams Meeting

**Start:** Thu 2022-07-28 2:30 PM  
**End:** Thu 2022-07-28 3:30 PM  
**Show Time As:** Tentative

**Recurrence:** (none)

**Organizer:** Gauthier, Rick

**Categories:** For ATIP

### Agenda:

Introductions

Current and future plans for SMRs at the Point Lepreau facility

Information regarding the designation process under the *Impact Assessment Act*, as well as other requirements under the Act and its potential application to any new SMRs

---

## Microsoft Teams meeting

### Join on your computer or mobile app

[Click here to join the meeting](#)

### Or join by entering a meeting ID

Meeting ID: 260 289 811 96

Passcode: 3ETiYe

### Or call in (audio only)

[+1 506-406-8124,274296633#](#) Canada, Fredericton

Phone Conference ID: 274 296 633#

[Find a local number](#) | [Reset PIN](#)



**Énergie NB Power**

the power of possibility | débordant d'énergie

[Learn More](#) | [Meeting options](#)

---

This e-mail communication (including any or all attachments) is intended only for the use of the person or entity to which it is addressed and may contain confidential and/or privileged material. If you are not the intended recipient of this e-mail, any use, review, retransmission, distribution, dissemination, copying, printing, or other use of, or taking of any action in reliance upon this e-mail, is strictly prohibited. If you have received this e-mail in error, please contact the sender and delete the original and any copy of this e-mail and any printout thereof, immediately. Your co-operation is appreciated.

Le présent courriel (y compris toute pièce jointe) s'adresse uniquement à son destinataire, qu'il soit une personne ou un organisme, et pourrait comporter des renseignements privilégiés ou confidentiels. Si vous n'êtes pas le destinataire du courriel, il est interdit d'utiliser, de revoir, de retransmettre, de distribuer, de disséminer, de copier ou d'imprimer ce courriel, d'agir en vous y fiant ou de vous en servir de toute autre façon. Si vous avez reçu le présent courriel par erreur, prière de communiquer avec l'expéditeur et d'éliminer l'original du courriel, ainsi que toute copie électronique ou imprimée de celui-ci, immédiatement. Nous sommes reconnaissants de votre collaboration.



# Advanced Small Modular Reactors in New Brunswick

IAAC Discussion

July 28, 2022

Rick Gauthier, Manager Licensing

Andrea McGathey, Senior Technical Specialist Environment

Claire Harris, Manager Engagement and Environment

# Agenda

- Canada's SMR Program
- Status of SMRs in New Brunswick
  - Timeline
  - Licensing Plans
- Environmental Reviews
- Discussion Topics

# Collaboration Industry and Government

- SMR Roadmap 2018
- CEO SMR Forum & various Industry groups - 2019
- Inter Provincial MOU 2019
- SMR Action Plan – Nov 2020
- Feasibility Study – March 2021
- Nuclear Hydrogen working group formed August 2021
- Strategic Plan March 2022



# SMR Pan-Canadian Approach

Stream	Application(s)	SMR technology	Potential Fleet Deployment Location(s)
1	Grid Based Electricity	GE Hitachi BWRX 300	Ontario Saskatchewan Alberta
2	Grid Based Heat Energy & Electricity	ARC 100	Atlantic Canada Saskatchewan Alberta
2	Spent Fuel Recycling & Grid Based Electricity & Heat Energy	Moltex WATTS & SSR-W	Atlantic Canada Ontario
3	Off-Grid Electricity & Heat Energy	Global First Power MMR	Northern Areas of Provinces Territories Remote Mines Shipping & Marine Applications
		Westinghouse eVinci	

# Activities in New Brunswick

- Selected ARC Clean Energy Canada Inc. and Moltex Energy
  - Both received funding to continue their designs
  - Both have established offices in Saint John
  - Advance the designs through the CNSC Vendor Design Review Phases
  - Assess feasibility of establishing supply chains
- Supply Chain Meetings with First Nations and NB suppliers
- First Nations and Public engagement
- Atlantic Clean Energy Alliance formed

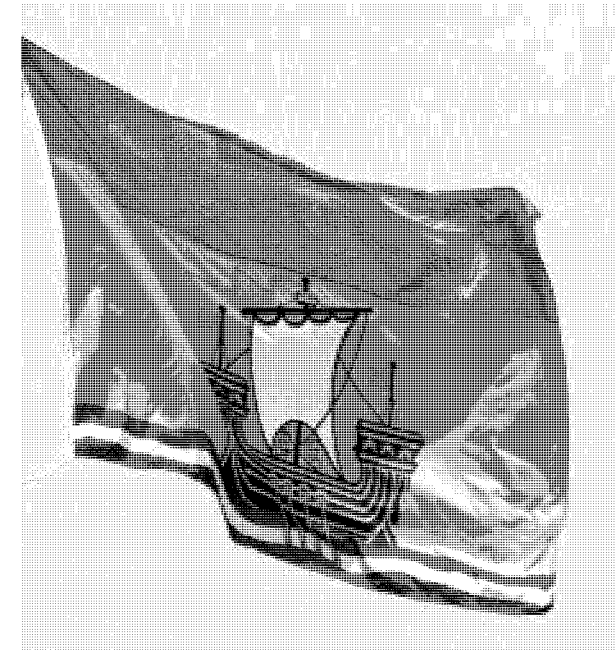

# Future Activities in New Brunswick

- Update the Integrated Resource Plan to address climate change
- Commercial demonstration of an ARC-100 at Point Lepreau
- Implement Indigenous Inclusion Guide
- Fleet deployment in New Brunswick / Canada / International markets
- Centralized fleet support center in NB
- Establish supply chain in NB and Canada

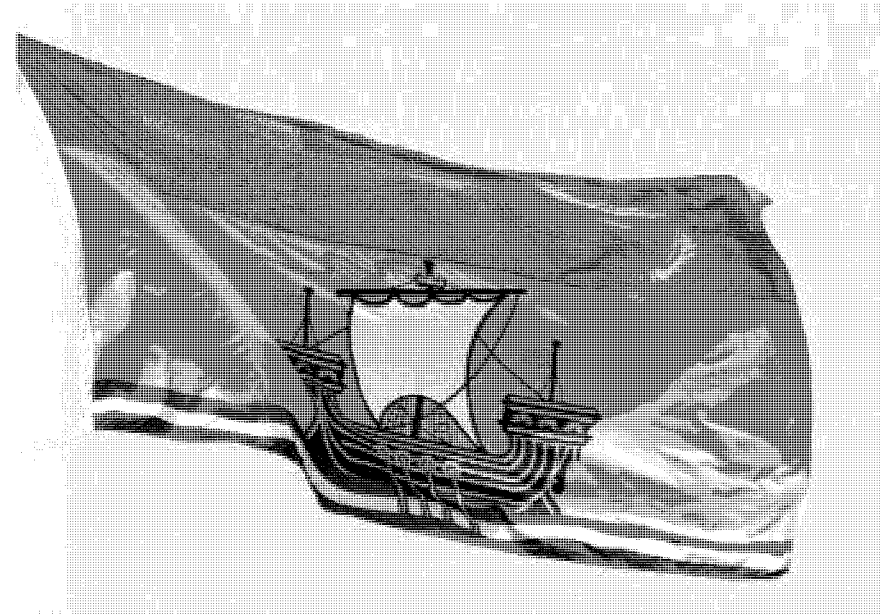

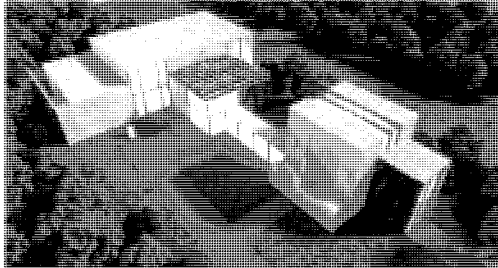

# ARC-100

## Sodium Cooled Fast Reactor

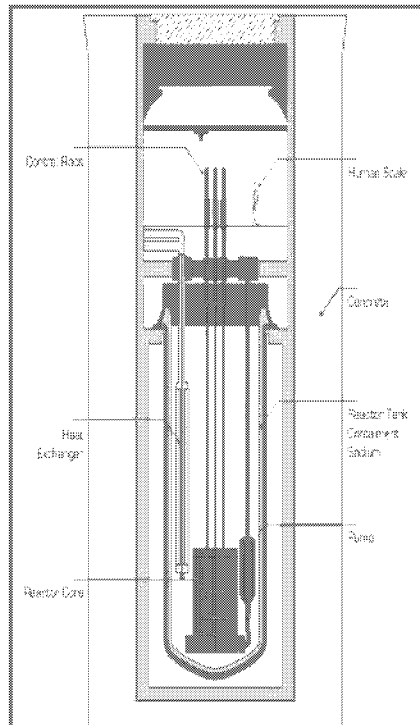

- 100-150 Mwe (286-429 Mwt) non-pressurized pool reactor
- **Based on 30-year operation at EBR-II**
- Inherent safety characteristics & Passive safety features
- 20 year fueling cycle
- Superior load following capability
- **Super heated steam for co-gen / hydrogen / synthetic fuel production**
- **Grid Supply**

CANADA

# COMMERCIAL DEMONSTRATION

Draft FOR DISCUSSION

COMPLETE

Phase 1

**Scoping Phase**

- Project Development & Execution Planning
  - » Cost & Schedule
- Establish Strategic Partners
- Conceptual Design

IN PROGRESS

Phase 2

**Preliminary Design**

- Canadian Nuclear Safety Commission (CNSC)
  - » Phase 2 Ready; Fall 2021
- Preliminary Design
- Validation of Cost Estimates & Integrated Schedule
- Scoping Fuel Supply & Manufacturing Capabilities

Phase 3

**Detailed Design**

- Complete Detailed Engineering / Constructability
- Procurement Orders (Supply Chain)
- Licensing & Approval for Construction Permit Issued
- Site Prep-Work Begins
- Execute Construction Contract

Phase 4

**Deploy ARC-100**

- Construction of ARC-100 Unit
- Test & Commissioning
- Commercial Operations
- Fleet Approach



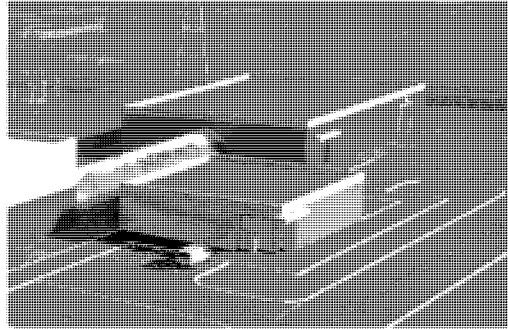

# Moltex Energy Molten Salt Reactor

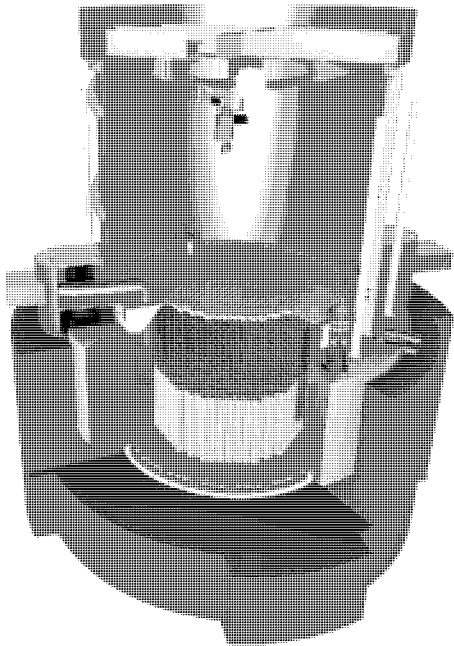

- 300 Mwe (750 Mwt) non pressurized pool reactor
- Inherent safety characteristics & passive safety features
- Fueled on-line
- Recycles its used fuel
- ***Fuelled by used CANDU fuel***
- ***Grid production***
- ***Grid reserve storage system***

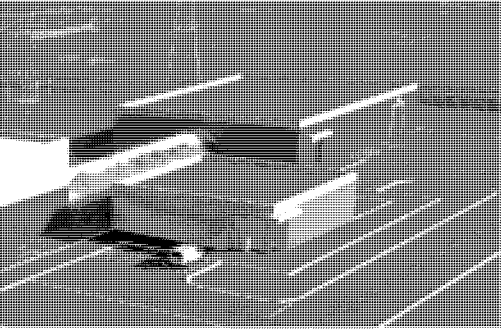

# Moltex Timelines

(Level 1 schedule under construction)

## SSR-W and WATSS

- WATSS - R&D & conceptual design in progress
- SSR-W - Finalizing conceptual design
- VDR1 complete and gaps being addressed
- Commercial operation late ~2030's

# Environmental Reviews

- Site characterization and environmental assessment being scoped to IAA TISG and CNSC REGDOC 1.1.1 and Provincial requirements
- Discussions ongoing with NB DELG and CNSC and IAAC (April 2022)
- ARC Commercial Demonstration Project EA will enter the Provincial Comprehensive Review
- Indigenous Inclusion throughout
- Public Engagement

# Discussion topics

- Opportunities for Regional or Strategic EA to streamline SMR approvals to address climate change
- Define project splitting
- Can the IAAC designate a project without a formal project being initiated?
- Linking EA to construction license verses site preparation
- How can we support IAAC with the designation request?
- Workshop being planned for Fall 2022 with IAAC

# Thank you



Advanced  
Develop  
Plan

✓ Class Plans

✓ Collaborate (Lead Study Group)

↳  
✓ Dev. class

✓ Andy Smith

Rock Access

Role Pro

Andru

ARD

Comversations

Interactive Plans

SMA Action Plan - Nov 2020

NRC Economic Panel

Public Hydrogen

working group

Energy advantage because of it

SMA Technology

✓ GE Hitachi Power Gen - D Water

✓ ARRC - PRO

10 000

to build

Current  
3rd  
Announcement

2030 for Commercial

(Funding for design)

Praxis / no uni by design  
Vendor 2018

of Muller 15mo for Fed gov  
of NB - 5

APL - 20mo Proment

Indigenous Indigenous by  
Vendor

NB → leads Collaboration

→ Indigenous cultural training

2 \$B projects, 2 \$B Teacher, 2 \$B Markets

Commercial demonstration of  
an 100-100 at Point Lynean

No doc - plant the size

↳ YouTube video

APL - West (Nuclear Waste Mgmt Campaign)

↳ used for a Muller health

June 2021 [Apple  
for preparation]

Apple  
Vendor

Indigenous  
Indigenous

Collaboration

Legacy  
of the  
Industry



CN 10

Contract for 2024

March  
No Project ARE 400

{ Frost }  
{ Heat }

→ DNS Power & Need 3 for Supply

2007

We don't have a project  
NB Power a host

Contract  
4.5G  
Bids 1.7M

Financial Empowerment Review Process

Contract  
2007

to determination

Contract  
2007

Energy Demand (MWh)

Availability of Capacity

Indigenous  
Inclusion

Power

Contract  
2007

Old use  
Regulation  
for Maltix

MS are - Project  
Part of Maltix  
x 1 million 3 vs 5



Muly & NB Power - July 28  
re DR on SMR  
SMR → Roadmap 2018-19  
SMR Action Plan → on line.

NB Power → settled on Arc  
liquid sodium  
→ looked at 1005 before settling.  
Could wait compared to ON

Molten salt used as fuel & used as fuel  
two tech don't compete & other

← Supply chain met in IG (2018)?

→ Funding from prov. govt \$ million R  
each vendor/  
matched by vendor.

Molten → \$50 million from fed govt.  
Aich → 20 " " prov. govt.

Engagement with FN / public → ~~FB~~ ~~FB~~

Indigenous inclusion guide

introduction of document  
pot - impacts  
→ study guidelines.

thoughts

→ initial submission to PWS? ~~at sea~~  
Sept/Oct.

→ Preliminary registration doc → Oct. 2022

100-150 Mwt (286-429 Mwt) non-  
pressurized pool reactor.

20 yr fueling cycle

Supr heated steam for co-gen/hydrogen  
synthetic fuel production.

Plan is to prepare a license June 2023  
to prepare site for CNSC.

license to center Dec. 2024.

no offer yet for Arc.

immediate plans → one unit to satisfy  
supply & demand

Molten → 750 Mwt

~~1999~~

transmission to the other side  
of the river  
using a bridge

→ NB

→ Moller timing → conceptual design  
like late 2030s  
complete of years away

Moller

important to have a clear  
vision of the future

Plan is to build a bridge  
to the other side  
of the river

1996 - 1997 - 1998

MA at top of the

→ ~~1999~~ 1999

1999



- Can the IAAC designate a project as a formal project being initiated?
- Opportunities for Ref of SEA to streamline SMR approvals to address climate change
- Project Splitting
- EA → construction licence vs side prep licence
- Workshop @ IAAC Fall
- timeline process → how long to complete

## Sabo,Ashley (IAAC/AEIC)

---

**From:** Gauthier, Rick <RGauthier@nbpower.com>  
**Sent:** July 28, 2022 8:02 AM  
**To:** Vigder,Joseph (IAAC/AEIC)  
**Cc:** Harris, Claire; McGathey, Andrea  
**Subject:** RE: EXT - RE: NB Power Contact - SMR Demonstration Project

**Categories:** For ATIP, Filed to GCDocs

Perfect, we are aligned.

Rick



Rick Gauthier  
*Licensing Manager*  
*Advanced Reactor Development Team*  
506.651.3286  
nbpower.com | energienb.com

**From:** Vigder,Joseph (IAAC/AEIC) <joseph.vigder@iaac-aeic.gc.ca>  
**Sent:** July 28, 2022 9:00 AM  
**To:** Gauthier, Rick <RGauthier@nbpower.com>  
**Subject:** RE: EXT - RE: NB Power Contact - SMR Demonstration Project

Thanks for adding the slides, Rick.

If it makes sense to you, I suggest after intros and what-not, you go through these slides. They contain the type of information we are interested in hearing about, and would provide a basis on which to discuss related issues.

Joe

**From:** Gauthier, Rick <RGauthier@nbpower.com>  
**Sent:** July 28, 2022 7:59 AM  
**To:** Vigder,Joseph (IAAC/AEIC) <joseph.vigder@iaac-aeic.gc.ca>  
**Subject:** RE: EXT - RE: NB Power Contact - SMR Demonstration Project

Joe, I added these slide to the meeting notice yesterday.

Rick



Rick Gauthier  
*Licensing Manager*  
*Advanced Reactor Development Team*  
506.651.3286  
nbpower.com | energienb.com

**From:** Vigder, Joseph (IAAC/AEIC) <[joseph.vigder@iaac-aeic.gc.ca](mailto:joseph.vigder@iaac-aeic.gc.ca)>  
**Sent:** July 25, 2022 3:44 PM  
**To:** Gauthier, Rick <[RGauthier@nbpower.com](mailto:RGauthier@nbpower.com)>  
**Subject:** RE: EXT - RE: NB Power Contact - SMR Demonstration Project

Hi Rick,

I just wanted to provide a bit of additional context regarding the designation request the Minister has received in preparation for the meeting on Thursday. The requestor has asked the Minister to consider the potentially proposed ARC SMR(s) and Moltex SMR as a single project and designate it for federal impact assessment under the Impact Assessment Act.

Among other information that NP Power is able to provide, the Agency would be interested in hearing about the status of these two potential SMRs, the relationships between them, NB Power, and the vendors; as well as any plans for licensing, approvals, or impact/environmental review for each.

Again, if you would like any additional information to help prepare for the discussion, or if there are specific items you would like to hear about from us, don't hesitate to reach out.

Thanks,  
Joe

**From:** Gauthier, Rick <[RGauthier@nbpower.com](mailto:RGauthier@nbpower.com)>  
**Sent:** July 25, 2022 7:36 AM  
**To:** Vigder, Joseph (IAAC/AEIC) <[joseph.vigder@iaac-aeic.gc.ca](mailto:joseph.vigder@iaac-aeic.gc.ca)>  
**Cc:** Adams, Jill (IAAC/AEIC) <[Jill.Adams@iaac-aeic.gc.ca](mailto:Jill.Adams@iaac-aeic.gc.ca)>; Belland, Brenna (IAAC/AEIC) <[Brenna.Belland@iaac-aeic.gc.ca](mailto:Brenna.Belland@iaac-aeic.gc.ca)>; Primeau, Eric (IAAC/AEIC) <[Eric.Primeau@iaac-aeic.gc.ca](mailto:Eric.Primeau@iaac-aeic.gc.ca)>; Katahwa, Kambale (IAAC/AEIC) <[kambale.katahwa@iaac-aeic.gc.ca](mailto:kambale.katahwa@iaac-aeic.gc.ca)>  
**Subject:** RE: EXT - RE: NB Power Contact - SMR Demonstration Project

Thanks Joe, I have set a calendar notice for a Teams meeting Thursday afternoon.  
Should we also invite  
Colette Spagnuolo

Director, Review Panels Division  
Impact Assessment Agency of Canada / Government of Canada  
[colette.spagnuolo@iaac-aeic.gc.ca](mailto:colette.spagnuolo@iaac-aeic.gc.ca) / Cel: 613-282-8245

I can add Colette to the notice if appropriate.



Rick Gauthier  
*Licensing Manager*  
*Advanced Reactor Development Team*  
506.651.3286  
[nbpower.com](http://nbpower.com) | [energienb.com](http://energienb.com)

**From:** Vigder, Joseph (IAAC/AEIC) <[joseph.vigder@iaac-aeic.gc.ca](mailto:joseph.vigder@iaac-aeic.gc.ca)>  
**Sent:** July 22, 2022 11:07 AM  
**To:** Gauthier, Rick <[RGauthier@nbpower.com](mailto:RGauthier@nbpower.com)>  
**Cc:** Adams, Jill (IAAC/AEIC) <[Jill.Adams@iaac-aeic.gc.ca](mailto:Jill.Adams@iaac-aeic.gc.ca)>; Belland, Brenna (IAAC/AEIC) <[Brenna.Belland@iaac-aeic.gc.ca](mailto:Brenna.Belland@iaac-aeic.gc.ca)>; Primeau, Eric (IAAC/AEIC) <[Eric.Primeau@iaac-aeic.gc.ca](mailto:Eric.Primeau@iaac-aeic.gc.ca)>; Katahwa, Kambale (IAAC/AEIC) <[kambale.katahwa@iaac-aeic.gc.ca](mailto:kambale.katahwa@iaac-aeic.gc.ca)>  
**Subject:** RE: EXT - RE: NB Power Contact - SMR Demonstration Project

Hi Rick,

It looks like the afternoon of Thursday, July 28<sup>th</sup> works best on our end for a meeting. Anytime after 2:30pm Atlantic (1:30pm Eastern) is fine. Please send the invite to myself as well as the following folks from the Agency (all cc'ed): Jill Adams, Brenna Belland, Eric Primeau, and Kambale Katahwa.

Beyond general introductions, we are interested in hearing from NB Power regarding its current and future plans for SMRs at the Point Lepreau facility.

It will also be an opportunity for us to provide some information regarding the designation process under the *Impact Assessment Act*, as well as other requirements under the Act and its potential application to any new SMRs. I did not plan on preparing any formal presentations or develop a formal agenda, but if there are specific items you would like to discuss, let me know and I can prepare accordingly.

If you have any questions before the meeting, don't hesitate to reach out.

Have a good weekend,

Joe

**From:** Gauthier, Rick <[RGauthier@nbpower.com](mailto:RGauthier@nbpower.com)>  
**Sent:** July 21, 2022 12:08 PM  
**To:** Vigder, Joseph (IAAC/AEIC) <[joseph.vigder@iaac-aeic.gc.ca](mailto:joseph.vigder@iaac-aeic.gc.ca)>  
**Cc:** Belyea, Sean <[Sean.Belyea@cnsccsn.gc.ca](mailto:Sean.Belyea@cnsccsn.gc.ca)>  
**Subject:** RE: EXT - RE: NB Power Contact - SMR Demonstration Project

Good day Joe and thanks for the email.

Yes we would like the opportunity to have this discussion virtually, if you could provide times that you would be available Thursday or Friday of next week I would be happy to schedule a meeting and invite our team members at NB Power.

I look forward to meeting you.

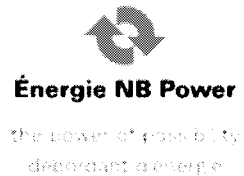

Rick Gauthier  
*Licensing Manager*  
*Advanced Reactor Development Team*  
506.651.3286  
[nbpower.com](http://nbpower.com) | [energienb.com](http://energienb.com)

**From:** Vigder, Joseph (IAAC/AEIC) <[joseph.vigder@iaac-aeic.gc.ca](mailto:joseph.vigder@iaac-aeic.gc.ca)>  
**Sent:** July 20, 2022 4:19 PM  
**To:** Gauthier, Rick <[RGauthier@nbpower.com](mailto:RGauthier@nbpower.com)>  
**Cc:** Belyea, Sean <[Sean.Belyea@cnsccsn.gc.ca](mailto:Sean.Belyea@cnsccsn.gc.ca)>  
**Subject:** EXT - RE: NB Power Contact - SMR Demonstration Project

\*\*\* Attention: External Message / Message externe \*\*\*

Good afternoon Rick (and thank you Sean for putting us in touch),

For some quick context, the Minister of Environment and Climate Change Canada has recently received a request to designate a proposed Small Modular Reactor (SMR) Demonstration Project at the Point Lepreau Nuclear Station under the *Impact Assessment Act*. We (the Impact Assessment Agency of Canada) are conducting an initial review.

At this point, I am looking for an appropriate contact at NB Power with whom we can work to provide a bit more information regarding the project, or projects, that are being planned. Please let me know if that would be yourself, and if anyone else at NB Power should be involved in any preliminary discussions or correspondence.

If possible, I think it would be worthwhile organizing a meeting in the next week or so where we can sit down (virtually at least) and discuss.



In the meantime, I am definitely available to chat or answer any preliminary questions you may have, so don't hesitate to reach out.

Thank you,

Joe

Joe Vigder  
(he/him | il)

Project Manager, Atlantic Region  
Impact Assessment Agency of Canada / Government of Canada  
[joseph.vigder@iaac-aeic.gc.ca](mailto:joseph.vigder@iaac-aeic.gc.ca) / Tel : 902-229-9637

Gestionnaire de projets, région atlantique  
Agence d'évaluation d'impact du Canada / Gouvernement du Canada  
[joseph.vigder@iaac-aeic.gc.ca](mailto:joseph.vigder@iaac-aeic.gc.ca) / Tél : 902-229-9637



Canada

**From:** Belyea, Sean <[Sean.Belyea@cnsccsn.gc.ca](mailto:Sean.Belyea@cnsccsn.gc.ca)>  
**Sent:** July 20, 2022 3:34 PM  
**To:** Vigder, Joseph (IAAC/AEIC) <[joseph.vigder@iaac-aeic.gc.ca](mailto:joseph.vigder@iaac-aeic.gc.ca)>  
**Cc:** Gauthier, Rick <[RGauthier@nbpower.com](mailto:RGauthier@nbpower.com)>  
**Subject:** RE: NB Power Contact - SMR Demonstration Project

Hi Joe,

I'm glad you found the meeting productive. I did as well.

The main contact I have for you at NB Power is Rick Gauthier, who is the Licensing Manager for the Advanced Reactor Development Team. I have copied him on this email.

I'm sure he'd be happy to talk with you about potential plans on the Point Lepreau site, or at the very least put you in contact with the appropriate contact at NB Power.

By all means let me know if I can help further.

Sean Belyea

Advanced Reactor Licensing Division / Division de l'autorisation des réacteurs avancés  
Canadian Nuclear Safety Commission | Commission canadienne de sûreté nucléaire  
Ottawa, Canada K1P 5S9

[sean.belyea@cnscccsn.gc.ca](mailto:sean.belyea@cnscccsn.gc.ca) (\*\* Note New Email!)

Telephone | Téléphone [343-573-8179](tel:343-573-8179) (\*\* Note New Number - Voice and SMS (text) Enabled \*\*)

**From:** Vigder, Joseph (IAAC/AEIC) <[joseph.vigder@iaac-aeic.gc.ca](mailto:joseph.vigder@iaac-aeic.gc.ca)>

**Sent:** July 20, 2022 1:27 PM

**To:** Belyea, Sean <[Sean.Belyea@cnscccsn.gc.ca](mailto:Sean.Belyea@cnscccsn.gc.ca)>

**Subject:** NB Power Contact - SMR Demonstration Project

---

EXTERNAL EMAIL – USE CAUTION / COURRIEL EXTERNE – FAITES PREUVE DE PRUDENCE

---

Hi Sean,

Thanks for all the context and information you shared at the meeting on Tuesday regarding the potential SMR Demonstration projects at Point Lepreau. I found it very helpful.

If possible, could you provide me with a contact(s) at NB Power who I could get in touch with regarding their potential plans? I was hoping to set up a meeting with them to discuss?

Thanks!

Joe Vigder  
(he/him | il)

Project Manager, Atlantic Region  
Impact Assessment Agency of Canada / Government of Canada  
[joseph.vigder@iaac-aeic.gc.ca](mailto:joseph.vigder@iaac-aeic.gc.ca) / Tel : 902-426-4951 / Cell : 902-229-9637

Gestionnaire de projets, région atlantique  
Agence d'évaluation d'impact du Canada / Gouvernement du Canada  
[joseph.vigder@iaac-aeic.gc.ca](mailto:joseph.vigder@iaac-aeic.gc.ca) / Tél : 902-426-4951 / Cel. : 902-229-9637



---

This e-mail communication (including any or all attachments) is intended only for the use of the person or entity to which it is addressed and may contain confidential and/or privileged material. If you are not the intended recipient of this e-mail, any use, review, retransmission, distribution, dissemination, copying, printing, or other use of, or taking of any action in reliance upon this e-mail, is strictly prohibited. If you have received this e-mail in error, please contact the sender and delete the original and any copy of this e-mail and any printout thereof, immediately. Your co-operation is appreciated.

Le présent courriel (y compris toute pièce jointe) s'adresse uniquement à son destinataire, qu'il soit une personne ou un organisme, et pourrait comporter des renseignements privilégiés ou confidentiels. Si vous n'êtes pas le destinataire du courriel, il est interdit d'utiliser, de revoir, de retransmettre, de distribuer, de disséminer, de copier ou d'imprimer ce courriel, d'agir en vous y fiant ou de vous en servir de toute autre façon. Si vous avez reçu le présent courriel par erreur, prière de communiquer avec l'expéditeur et d'éliminer l'original du courriel, ainsi que toute copie électronique ou imprimée de celui-ci, immédiatement. Nous sommes reconnaissants de votre collaboration.

Meeting w NB Power

Date

- SMR Action Plan
- NB Economic Feasibility Stud
  - Cross-Canada SMR feasibility study
- ARC ready for commercial deployment in ~2030's
- Funding from who?
  - NB Power I assume is leading engagement etc. w vendors as tech support
- Funding received from prov gov.
- Molten received \$50 mil; NB Power received amount for research
- Info needed on waste streams
- Plan to apply for "licence to prepare site" in June 2023
- Plan for licence to construction Dec 2024
- ~~ARC~~ Only plans currently for 1 ARC-100 SMR
- Still looking for investors
  - Main investor ~~will likely~~ become proponent
  - NB Power will be licensee (and likely proponent, but could be main investor)

## Sabo,Ashley (IAAC/AEIC)

---

**From:** Vigder,Joseph (IAAC/AEIC)  
**Sent:** August 4, 2022 12:13 PM  
**To:** Gauthier, Rick  
**Cc:** Harris, Claire  
**Subject:** RE: EXT - RE: NB Power Contact - SMR Demonstration Project

**Categories:** For ATIP, Filed to GCDocs

Hi Rick,

That is correct. I am working on a request for information now. I suggest we wait until that has been provided to you, and then schedule another meeting, as required.

However, I am available to chat in the meantime if you have any questions.

And thanks to you and the others at NB Power as well for the meeting last week. It was very useful.

Joe

**From:** Gauthier, Rick <RGauthier@nbpower.com>  
**Sent:** August 4, 2022 1:02 PM  
**To:** Vigder,Joseph (IAAC/AEIC) <joseph.vigder@iaac-aeic.gc.ca>  
**Cc:** Harris, Claire <CHarris@nbpower.com>  
**Subject:** RE: EXT - RE: NB Power Contact - SMR Demonstration Project

Joe, thanks again for your time last week. This is a follow up note to confirm that we will receive a request for information from your department and schedule another meeting.

Thanks



Rick Gauthier  
*Licensing Manager*  
*Advanced Reactor Development Team*  
506.651.3286  
nbpower.com | energienb.com

**From:** Vigder,Joseph (IAAC/AEIC) <[joseph.vigder@iaac-aeic.gc.ca](mailto:joseph.vigder@iaac-aeic.gc.ca)>  
**Sent:** July 25, 2022 3:44 PM  
**To:** Gauthier, Rick <[RGauthier@nbpower.com](mailto:RGauthier@nbpower.com)>  
**Subject:** RE: EXT - RE: NB Power Contact - SMR Demonstration Project

Hi Rick,

I just wanted to provide a bit of additional context regarding the designation request the Minister has received in preparation for the meeting on Thursday. The requestor has asked the Minister to consider the potentially proposed ARC SMR(s) and Moltex SMR as a single project and designate it for federal impact assessment under the Impact Assessment Act.

Among other information that NP Power is able to provide, the Agency would be interested in hearing about the status of these two potential SMRs, the relationships between them, NB Power, and the vendors; as well as any plans for licensing, approvals, or impact/environmental review for each.

Again, if you would like any additional information to help prepare for the discussion, or if there are specific items you would like to hear about from us, don't hesitate to reach out.

Thanks,  
Joe

**From:** Gauthier, Rick <[RGauthier@nbpower.com](mailto:RGauthier@nbpower.com)>  
**Sent:** July 25, 2022 7:36 AM  
**To:** Vigder,Joseph (IAAC/AEIC) <[joseph.vigder@iaac-aeic.gc.ca](mailto:joseph.vigder@iaac-aeic.gc.ca)>  
**Cc:** Adams,Jill (IAAC/AEIC) <[Jill.Adams@iaac-aeic.gc.ca](mailto:Jill.Adams@iaac-aeic.gc.ca)>; Belland,Brenna (IAAC/AEIC) <[Brenna.Belland@iaac-aeic.gc.ca](mailto:Brenna.Belland@iaac-aeic.gc.ca)>; Primeau,Eric (IAAC/AEIC) <[Eric.Primeau@iaac-aeic.gc.ca](mailto:Eric.Primeau@iaac-aeic.gc.ca)>; Katahwa,Kambale (IAAC/AEIC) <[kambale.katahwa@iaac-aeic.gc.ca](mailto:kambale.katahwa@iaac-aeic.gc.ca)>  
**Subject:** RE: EXT - RE: NB Power Contact - SMR Demonstration Project

Thanks Joe, I have set a calendar notice for a Teams meeting Thursday afternoon.

Should we also invite  
Colette Spagnuolo  
Director, Review Panels Division  
Impact Assessment Agency of Canada / Government of Canada  
[colette.spagnuolo@iaac-aeic.gc.ca](mailto:colette.spagnuolo@iaac-aeic.gc.ca) / Cel: 613-282-8245

I can add Colette to the notice if appropriate.



Rick Gauthier  
Licensing Manager  
Advanced Reactor Development Team  
506.651.3286  
nbpower.com | energienb.com

**From:** Vigder, Joseph (IAAC/AEIC) <joseph.vigder@iaac-aeic.gc.ca>  
**Sent:** July 22, 2022 11:07 AM  
**To:** Gauthier, Rick <RGauthier@nbpower.com>  
**Cc:** Adams, Jill (IAAC/AEIC) <Jill.Adams@iaac-aeic.gc.ca>; Belland, Brenna (IAAC/AEIC) <Brenna.Belland@iaac-aeic.gc.ca>; Primeau, Eric (IAAC/AEIC) <Eric.Primeau@iaac-aeic.gc.ca>; Katahwa, Kambale (IAAC/AEIC) <kambale.katahwa@iaac-aeic.gc.ca>  
**Subject:** RE: EXT - RE: NB Power Contact - SMR Demonstration Project

Hi Rick,

It looks like the afternoon of Thursday, July 28<sup>th</sup> works best on our end for a meeting. Anytime after 2:30pm Atlantic (1:30pm Eastern) is fine. Please send the invite to myself as well as the following folks from the Agency (all cc'ed): Jill Adams, Brenna Belland, Eric Primeau, and Kambale Katahwa.

Beyond general introductions, we are interested in hearing from NB Power regarding its current and future plans for SMRs at the Point Lepreau facility.

It will also be an opportunity for us to provide some information regarding the designation process under the *Impact Assessment Act*, as well as other requirements under the Act and its potential application to any new SMRs. I did not plan on preparing any formal presentations or develop a formal agenda, but if there are specific items you would like to discuss, let me know and I can prepare accordingly.

If you have any questions before the meeting, don't hesitate to reach out.

Have a good weekend,

Joe

**From:** Gauthier, Rick <RGauthier@nbpower.com>  
**Sent:** July 21, 2022 12:08 PM  
**To:** Vigder, Joseph (IAAC/AEIC) <joseph.vigder@iaac-aeic.gc.ca>  
**Cc:** Belyea, Sean <Sean.Belyea@cnsccsn.gc.ca>  
**Subject:** RE: EXT - RE: NB Power Contact - SMR Demonstration Project

Good day Joe and thanks for the email.

Yes we would like the opportunity to have this discussion virtually, if you could provide times that you would be available Thursday or Friday of next week I would be happy to schedule a meeting and invite our team members at NB Power.  
I look forward to meeting you.



Rick Gauthier  
*Licensing Manager*  
*Advanced Reactor Development Team*  
506.651.3286  
nbpower.com | energienb.com

**From:** Vigder, Joseph (IAAC/AEIC) <joseph.vigder@iaac-aeic.gc.ca>  
**Sent:** July 20, 2022 4:19 PM  
**To:** Gauthier, Rick <RGauthier@nbpower.com>  
**Cc:** Belyea, Sean <Sean.Belyea@cnsccsn.gc.ca>  
**Subject:** EXT - RE: NB Power Contact - SMR Demonstration Project

\*\*\* Attention: External Message / Message externe \*\*\*

Good afternoon Rick (and thank you Sean for putting us in touch),

For some quick context, the Minister of Environment and Climate Change Canada has recently received a request to designate a proposed Small Modular Reactor (SMR) Demonstration Project at the Point Lepreau Nuclear Station under the *Impact Assessment Act*. We (the Impact Assessment Agency of Canada) are conducting an initial review.

At this point, I am looking for an appropriate contact at NB Power with whom we can work to provide a bit more information regarding the project, or projects, that are being planned. Please let me know if that would be yourself, and if anyone else at NB Power should be involved in any preliminary discussions or correspondence.

If possible, I think it would be worthwhile organizing a meeting in the next week or so where we can sit down (virtually at least) and discuss.

In the meantime, I am definitely available to chat or answer any preliminary questions you may have, so don't hesitate to reach out.

Thank you,

Joe

Joe Vigder



(he/him | il)

Project Manager, Atlantic Region  
Impact Assessment Agency of Canada / Government of Canada  
[joseph.vigder@iaac-aeic.gc.ca](mailto:joseph.vigder@iaac-aeic.gc.ca) / Tel : 902-229-9637

Gestionnaire de projets, région atlantique  
Agence d'évaluation d'impact du Canada / Gouvernement du Canada  
[joseph.vigder@iaac-aeic.gc.ca](mailto:joseph.vigder@iaac-aeic.gc.ca) / Tél : 902-229-9637



Canada

**From:** Belyea, Sean <[Sean.Belyea@cnsccsn.gc.ca](mailto:Sean.Belyea@cnsccsn.gc.ca)>  
**Sent:** July 20, 2022 3:34 PM  
**To:** Vigder, Joseph (IAAC/AEIC) <[joseph.vigder@iaac-aeic.gc.ca](mailto:joseph.vigder@iaac-aeic.gc.ca)>  
**Cc:** Gauthier, Rick <[RGauthier@nbpower.com](mailto:RGauthier@nbpower.com)>  
**Subject:** RE: NB Power Contact - SMR Demonstration Project

Hi Joe,

I'm glad you found the meeting productive. I did as well.

The main contact I have for you at NB Power is Rick Gauthier, who is the Licensing Manager for the Advanced Reactor Development Team. I have copied him on this email.

I'm sure he'd be happy to talk with you about potential plans on the Point Lepreau site, or at the very least put you in contact with the appropriate contact at NB Power.

By all means let me know if I can help further.

Sean Belyea  
Advanced Reactor Licensing Division / Division de l'autorisation des réacteurs avancés  
Canadian Nuclear Safety Commission | Commission canadienne de sûreté nucléaire  
Ottawa, Canada K1P 5S9  
[sean.belyea@cnsccsn.gc.ca](mailto:sean.belyea@cnsccsn.gc.ca) (\*\* Note New Email!)  
Telephone | Téléphone [343-573-8179](tel:343-573-8179) (\*\* Note New Number - Voice and SMS (text) Enabled \*\*)

**From:** Vigder, Joseph (IAAC/AEIC) <[joseph.vigder@iaac-aeic.gc.ca](mailto:joseph.vigder@iaac-aeic.gc.ca)>  
**Sent:** July 20, 2022 1:27 PM  
**To:** Belyea, Sean <[Sean.Belyea@cnsccsn.gc.ca](mailto:Sean.Belyea@cnsccsn.gc.ca)>  
**Subject:** NB Power Contact - SMR Demonstration Project

---

EXTERNAL EMAIL – USE CAUTION / COURRIEL EXTERNE – FAITES PREUVE DE PRUDENCE

---

Hi Sean,

Thanks for all the context and information you shared at the meeting on Tuesday regarding the potential SMR Demonstration projects at Point Lepreau. I found it very helpful.

If possible, could you provide me with a contact(s) at NB Power who I could get in touch with regarding their potential plans? I was hoping to set up a meeting with them to discuss?

Thanks!

Joe Vigder  
(he/him | il)

Project Manager, Atlantic Region  
Impact Assessment Agency of Canada / Government of Canada  
[joseph.vigder@iaac-aeic.gc.ca](mailto:joseph.vigder@iaac-aeic.gc.ca) / Tel : 902-426-4951 / Cell : 902-229-9637

Gestionnaire de projets, région atlantique  
Agence d'évaluation d'impact du Canada / Gouvernement du Canada  
[joseph.vigder@iaac-aeic.gc.ca](mailto:joseph.vigder@iaac-aeic.gc.ca) / Tél : 902-426-4951 / Cel. : 902-229-9637



Canada

---

This e-mail communication (including any or all attachments) is intended only for the use of the person or entity to which it is addressed and may contain confidential and/or privileged material. If you are not the intended recipient of this e-mail, any use, review, retransmission, distribution, dissemination, copying, printing, or other use of, or taking of any action in reliance upon this e-mail, is strictly prohibited. If you have received this e-mail in error, please contact the sender and delete the original and any copy of this e-mail and any printout thereof, immediately. Your co-operation is appreciated.

Le présent courriel (y compris toute pièce jointe) s'adresse uniquement à son destinataire, qu'il soit une personne ou un organisme, et pourrait comporter des renseignements privilégiés ou confidentiels. Si vous n'êtes pas le destinataire du courriel, il est interdit d'utiliser, de revoir, de retransmettre, de

distribuer, de disséminer, de copier ou d'imprimer ce courriel, d'agir en vous y fiant ou de vous en servir de toute autre façon. Si vous avez reçu le présent courriel par erreur, prière de communiquer avec l'expéditeur et d'éliminer l'original du courriel, ainsi que toute copie électronique ou imprimée de celui-ci, immédiatement. Nous sommes reconnaissants de votre collaboration.

## Sabo,Ashley (IAAC/AEIC)

---

**From:** Belland,Brenna (IAAC/AEIC)  
**Sent:** August 11, 2022 3:56 PM  
**To:** Heather.Harpell@cnsccsn.gc.ca; Way, Jessica  
**Cc:** Vigder,Joseph (IAAC/AEIC); Primeau,Eric (IAAC/AEIC)  
**Subject:** FW: Notification and Request for Information - Designation Request for SMR Demonstration Project  
**Attachments:** Letter to NB Power (Notification and Request for Information) - Designation Request under IAA.pdf; CRED-NB SMR Designation Request - July 4 2022 (004).pdf

**Categories:** ATIP

UNCLASSIFIED - NON CLASSIFIÉ

Hi Heather and Jes,

It was great to meet both of you!

As discussed, here is the letter that was sent to NB Power yesterday. Please note that Sean Belyea was CC'ed in the original correspondence, but I wanted to bring it to your attention as well. Please let me know if you have any questions.

Thanks again for taking the time to meet today, it was a pleasure.

Brenna

Brenna Belland, B.Sc., MEnv.  
(she/her/elle)  
Panel Analyst / Review Panels Division  
Impact Assessment Agency of Canada / Government of Canada  
Analyste des commissions / Division des commissions d'examen  
Agence d'évaluation d'impact du Canada / Gouvernement du Canada  
[brenna.belland@iaac-aeic.gc.ca](mailto:brenna.belland@iaac-aeic.gc.ca) / Cel: 343-549-2113

**From:** Vigder,Joseph (IAAC/AEIC) <joseph.vigder@iaac-aeic.gc.ca>  
**Sent:** August 10, 2022 12:39 PM  
**To:** Gauthier, Rick <RGauthier@nbpower.com>  
**Cc:** Harris, Claire <CHarris@nbpower.com>; Hayward, Andy <AHayward@nbpower.com>; McGathey, Andrea <AMcGathey@nbpower.com>; Adams,Jill (IAAC/AEIC) <Jill.Adams@iaac-aeic.gc.ca>; Katahwa,Kambale (IAAC/AEIC) <kambale.katahwa@iaac-aeic.gc.ca>; Belland,Brenna (IAAC/AEIC) <Brenna.Belland@iaac-aeic.gc.ca>;

Primeau, Eric (IAAC/AEIC) <Eric.Primeau@iaac-aeic.gc.ca>; Belyea, Sean <Sean.Belyea@cnscccsn.gc.ca>

**Subject:** Notification and Request for Information - Designation Request for SMR Demonstration Project

UNCLASSIFIED - NON CLASSIFIÉ

Hello Rick,

Please find attached a letter from the Impact Assessment Agency of Canada regarding a request sent to the Minister of Environment and Climate Change to designate a proposed Small Modular Reactor Demonstration Project under the *Impact Assessment Act*.

The original request sent to the Minister is also attached for your information.

Do not hesitate to reach out if you have any questions or would like to discuss the contents of the letter and the information requested.

Thank you,

Joe Vigder  
(he/him | il)

Project Manager, Atlantic Region  
Impact Assessment Agency of Canada / Government of Canada  
[joseph.vigder@iaac-aeic.gc.ca](mailto:joseph.vigder@iaac-aeic.gc.ca) / Tel : 902-229-9637

Gestionnaire de projets, région atlantique  
Agence d'évaluation d'impact du Canada / Gouvernement du Canada  
[joseph.vigder@iaac-aeic.gc.ca](mailto:joseph.vigder@iaac-aeic.gc.ca) / Tél : 902-229-9637



Impact Assessment  
Agency of CanadaAgence d'évaluation  
d'impact du CanadaSuite 200  
1801 Hollis Street  
Halifax NS B3J 3N4Bureau 200  
1801 rue Hollis  
Halifax, NS B3J 3N4

August 10, 2022

**ELECTRONIC MAIL**Rick Gauthier  
Licensing Manager  
Énergie NB Power  
RGauthier@nbpower.com

Dear Mr. Gauthier,

**SUBJECT: Designation Request for the Small Modular Reactor  
Demonstration Project, New Brunswick**

On July 4, 2022, the Minister of Environment and Climate Change (the Minister) received a request to designate a proposed Small Modular Reactor (SMR) Demonstration Project (the Project) under subsection 9(1) of the *Impact Assessment Act* (the IAA). The letter requesting designation is enclosed for your information.

**Prerequisite for Initiating a Designation Request**

Before the Impact Assessment Agency of Canada (the Agency) initiates its review of the request to designate the Project, the Agency must first review available information to evaluate whether or not the Project is described in the *Physical Activities Regulations* (the Project List). The evaluation may include seeking information from the proponent, as appropriate. If the Project is described on the Project List, it would already be a designated project and subject to the requirements of the IAA. Therefore, section 9 of the IAA could not apply.

Additional information regarding the process for designation requests can be found at the following link: <https://www.canada.ca/en/impact-assessment-agency/services/policy-guidance/designating-project-impact-assessment-act.html>.

.../2



Impact Assessment  
Agency of Canada

Agence d'évaluation  
d'impact du Canada

Suite 200  
1801 Hollis Street  
Halifax NS B3J 3N4

Bureau 200  
1801 rue Hollis  
Halifax, NS B3J 3N4

-2-

The Agency understands that NB Power is potentially proposing to construct and operate one or more SMRs at the Point Lepreau Nuclear Station in New Brunswick. The operation of the new SMR(s) may also involve additional new requirements for the long-term management or disposal of irradiated nuclear fuel or nuclear waste.

Please note, the following activities are described on the Project List:

**27** The site preparation for, and the construction, operation and decommissioning of, one or more new nuclear fission or fusion reactors if

(a) that activity is located within the licensed boundaries of an existing Class IA nuclear facility and the new reactors have a combined thermal capacity of more than 900 MWth; or

(b) that activity is not located within the licensed boundaries of an existing Class IA nuclear facility and the new reactors have a combined thermal capacity of more than 200 MWth.

**28** The construction and operation of either of the following:

(a) a new facility for the storage of irradiated nuclear fuel or nuclear waste, outside the licensed boundaries of an existing *nuclear facility*, as defined in section 2 of the *Nuclear Safety and Control Act*, other than a facility for the on-site storage of irradiated nuclear fuel or nuclear waste associated with one or more new fission or fusion reactors that have a combined thermal capacity of less than 200 MWth;

(b) a new facility for the long-term management or disposal of irradiated nuclear fuel or nuclear waste.

**29** The expansion of an existing facility for the long-term management or disposal of irradiated nuclear fuel or nuclear waste, if the expansion would result in an increase in the area of the facility, at ground level, of 50% or more.

If a proponent is proposing to conduct any of these activities, or any other activity that is described on the Project List, the requirements of the IAA would apply, including the prohibitions listed under section 7.

.../3



Impact Assessment  
Agency of Canada

Agence d'évaluation  
d'impact du Canada

Suite 200  
1801 Hollis Street  
Halifax NS B3J 3N4

Bureau 200  
1801 rue Hollis  
Halifax, NS B3J 3N4

-3-

To inform its initial review of whether or not the Project is described on the Project List, the Agency requires additional information regarding NB Power's currently proposed and potential future activities related to SMRs. This includes information regarding the nature and scope of these activities, as well as information to determine if NB Power is proposing separate stand-alone projects, or a single multi-phased demonstration project involving multiple SMRs. The Agency requests NB Power provide any available information that may aid in conducting the review, including the following:

- the role of NB Power in relation to the Project, and information on the roles and responsibilities and relationships between NB Power, the SMR vendors, and any third party or other party involved;
- key activities and components being proposed, including:
  - the total number of SMRs being proposed and the thermal capacity of each; and the relationship, or lack therefor, between the proposed SMRs, to understand if NB Power is proposing a single multi-phased project or separate projects;
  - anticipated requirements for the management, storage, or disposal of irradiated nuclear fuel or nuclear waste;
- activities currently underway and estimated timelines for planning, approvals, construction, operation, and decommissioning;
- a list of known or anticipated regulatory approvals (federal, provincial, municipal, other);
- NB Power's views regarding whether any of its proposed or potential future activities are described on the Project List; and
- any other information NB Power is able to provide that may be relevant in the Agency's review.

Following a review of the available information, if it is confirmed that the Project is described on the Project List, NB Power would be required to submit an initial project description in accordance with subsection 10(1) of the IAA. If the Project is not on the Project List, the Agency will proceed with the process for designation requests submitted to the Minister.

## Process for Designation Requests

.../4



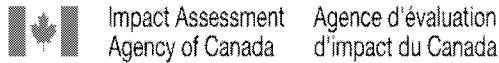

Suite 200  
1801 Hollis Street  
Halifax NS B3J 3N4

Bureau 200  
1801 rue Hollis  
Halifax, NS B3J 3N4

-4-

If it is confirmed that the Project is not described on the Project List, the Agency will consider whether sufficient information has been provided by the requester to commence the designation request process. If sufficient information has been provided, the Agency will commence the designation request process, and the Minister will have 90 days to decide whether or not they wish to designate the Project under subsection 9(1) of the IAA, and provide a response to the requester with reasons for their decision. The Minister may designate a physical activity if, in the Minister's opinion, the physical activity may cause adverse effects within federal jurisdiction or adverse direct or incidental effects (resulting from federal decisions), or public concerns related to those effects warrant the designation. The Agency would review information about the Project; any concerns expressed from the public and Indigenous groups; and expert advice from federal authorities and input from provincial ministries, in order to inform the Minister on whether to designate the Project.

If such a review is required, the Agency may request additional information from you about the Project at that time. However, if any of this information is currently available, it may expedite the potential review process, or may be relevant to the Agency's initial review to determine if the Project is on the Project List. Additional information that may be requested could include details regarding any:

- potential adverse effects to fish and fish habitat, migratory birds and species at risk;
- potential adverse changes to the environment that would occur on federal lands and lands outside New Brunswick or Canada;
- greenhouse gas emissions including loss of carbon sequestration;
- potential adverse impacts resulting from any change to the environment on Indigenous peoples (e.g. changes to the environment impacting physical and cultural heritage, current use of lands and resources for traditional purposes, and structures, sites or things of historical, archaeological, paleontological or architectural significance) or changes to their health, social or economic conditions;
- potential adverse impacts on the rights of Indigenous peoples recognized and affirmed by section 35 of the *Constitution Act*; and
- potential adverse effects (changes to the environment or to health, social or economic conditions) that are directly linked or necessarily incidental to a federal authority's exercise of a power, performance of a duty or function, or provision of financial assistance, that would enable the carrying out of the Project, in whole or in part.

.../5



Suite 200  
 1801 Hollis Street  
 Halifax NS B3J 3N4

Bureau 200  
 1801 rue Hollis  
 Halifax, NS B3J 3N4

-5-

In particular, the Agency requests available information regarding:

1. Information about key project activities, maps and layouts of the location of project components, land tenure, and zoning.
2. Any federal financial assistance that would be required, or has already been attained or provided, for the Project and the associated project components or activities.
3.
  - a) For each regulatory approval that would be required, please provide the following information:
    - i. Name of the licence, permit, authorization or approval, the associated legislative framework, and the responsible jurisdiction.
    - ii. The status of attaining any regulatory approvals.
    - iii. Whether it would involve an assessment of any of the effects outlined in the paragraphs above, and if so, a general description of the assessment that you intend to undertake and if applicable, any benchmarks or standards you intend to meet. Would conditions be set and if yes, what effects would those conditions address?
    - iv. Whether public and/or Indigenous consultation would be required and if yes, provide information on the approach you intend to take (if any steps have been taken, please provide a summary, including issues raised as well as your responses). If the Project is anticipated to result in permanent changes or cumulative effects, how you intend to manage those impacts.
  - b) Identify whether any licence, permit, authorization or approval listed above would address any of the following matters:
    - i. Cumulative effects, effects of potential accidents or malfunctions, alternatives to and alternative means of carrying out the project, long-term management of waste, and the non-proliferation of nuclear weapons.
    - ii. If yes, discuss, in general, the benchmarks or standards that you intend to meet (or would be expected to meet).
    - iii. If the Project is anticipated to result in permanent changes or cumulative effects, how you intend to manage those impacts.

.../6



Suite 200  
1801 Hollis Street  
Halifax NS B3J 3N4

Bureau 200  
1801 rue Hollis  
Halifax, NS B3J 3N4

-6-

4. For all federal licences, permits, authorizations, approvals, and/or financial assistance that has or may be provided for the Project, describe any anticipated adverse direct or incidental effects (including changes to health, social and economic conditions) that may occur as a result.
5. What steps have you taken to consult with the public? What steps do you plan to undertake during all phases of the Project? Are you aware of any public concerns in relation to this project? If yes, provide an overview of the key issues and the way in which (in general terms) you intend to address these matters?
6. What steps have you taken to engage or consult with Indigenous communities? What steps do you plan to undertake during all phases of the Project? Are you aware of any Indigenous community concerns in relation to this project? If yes, provide an overview of the key issues and the way in which (in general terms) you plan to address these matters?
7. Do you have any other comments in relation to environmental effects or impacts to the public or Indigenous peoples and how you intend to address and manage those?
8. Explain your views on whether the Project should be designated under the IAA.

...17



Impact Assessment Agency of Canada  
Agence d'évaluation d'impact du Canada

Suite 200  
1801 Hollis Street  
Halifax NS B3J 3N4

Bureau 200  
1801 rue Hollis  
Halifax, NS B3J 3N4

-7-

**Important Note:** All records produced, collected or received in relation to the designation request process – unless prohibited under the *Access to Information Act* or *Privacy Act* – will be considered public and may be released. Should you wish to provide any comments or documents that contain confidential or sensitive information that you believe should be protected from release to the public, please contact the Agency before submitting the information. Information marked as confidential will not be accepted without prior contact made with the Agency.

Further questions regarding this request can be directed to me at 902-229-9637 or [joseph.vigder@iaac-aeic.gc.ca](mailto:joseph.vigder@iaac-aeic.gc.ca).

Sincerely,

Joseph Vigder  
Project Manager, Atlantic Region

Enclosure: Request for Designation

c.c. (email):

- C. Harris – NB Power
- A. Hayward – NB Power
- A. McGathey – NB Power
- J. Adams – Impact Assessment Agency of Canada
- K. Katahwa – Impact Assessment Agency of Canada
- B. Belland – Impact Assessment Agency of Canada
- E. Primeau – Impact Assessment Agency of Canada
- S. Belyea – Canadian Nuclear Safety Commission

**From:** CRED New Brunswick

**Sent:** July 4, 2022 6:18:58 AM

**To:** ec.ministre-minister.ec@canada.ca

**Cc:** information@iaac-aeic.gc.ca; L'honorable Marc Miller; L'honorable Jean-Yves Duclos; The Honourable Jonathan Wilkinson; The Honourable Chrystia Freeland; francois-philippe.champagne@parl.gc.ca; L'honorable Mélanie Joly; L'honorable Dominic LeBlanc; ginette.petitpastaylor@parl.gc.ca; candice.bergen@parl.gc.ca; Jagmeet.Singh@parl.gc.ca; Yves-Francois.Blanchet@parl.gc.ca; Elizabeth.May@parl.gc.ca; Higgs, Premier Blaine (PO/CPM); Arlene.Dunn@gnb.ca; Gary.Crossman@gnb.ca; Dorothy.Shephard@gnb.ca; Mike.Holland@gnb.ca; Roger.L.Melanson@gnb.ca; David.Coon@gnb.ca; Ernie.Steeves@gnb.ca

**Subject:** Small Modular Reactor (SMR) Demonstration Project, New Brunswick - Request for Designation under s. 9 of the Impact Assessment Act

**Response requested:** Yes

**Sensitivity:** Normal

**Attachments:**

2022-07-02-CRED-NB-Minister Guilbeault.pdf;

---

You don't often get email from cred.nb@gmail.com. [Learn why this is important](#)

Honourable Minister Steven Guilbeault  
Minister of Environment and Climate Change  
Fontaine Building 12th floor  
200 Sacré-Coeur Blvd  
Gatineau QC K1A 0H3

Sent via email

July 4, 2022

Dear Minister Guilbeault,

On behalf of our membership, we write to request you exercise your authority pursuant to section 9(1) of the *Impact Assessment Act* to designate the proposed Small Modular Nuclear Reactor (SMR) demonstration project at Point Lepreau, New Brunswick for a federal impact assessment. This request is supported by groups across Canada.

Attached please find our formal request.

We are also asking for a meeting to discuss our request with you at your earliest convenience.

Please acknowledge receipt of this email. Thank you.

Regards,

Ann McAllister, Rothesay, New Brunswick  
Roy Ries, Harvey, Albert County, New Brunswick  
Sam Arnold, Woodstock, New Brunswick  
on behalf of the Coalition for Responsible Energy Development in New Brunswick (CRED-NB)

cc: Impact Assessment Agency of Canada

**Pages 75 to / à 150  
are withheld pursuant to section  
sont retenues en vertu de l'article**

**68(a)**

**of the Access to Information  
de la Loi sur l'accès à l'information**

**Sabo,Ashley (IAAC/AEIC)**

---

**From:** Gauthier, Rick <RGauthier@nbpower.com>  
**Sent:** August 23, 2022 11:26 AM  
**To:** Vigder,Joseph (IAAC/AEIC)  
**Cc:** Harris, Claire; Katahwa,Kambale (IAAC/AEIC); Adams,Jill (IAAC/AEIC)  
**Subject:** RE: EXT - RE: Notification and Request for Information - Designation Request for SMR Demonstration Project

**Categories:** For ATIP

yes we will include Jill Adams on the response.



Rick Gauthier  
*Licensing Manager*  
*Advanced Reactor Development Team*  
 506.651.3286  
 nbpower.com | energienb.com

**From:** Vigder,Joseph (IAAC/AEIC) <joseph.vigder@iaac-aeic.gc.ca>  
**Sent:** August 23, 2022 12:16 PM  
**To:** Gauthier, Rick <RGauthier@nbpower.com>  
**Cc:** Harris, Claire <CHarris@nbpower.com>; Katahwa,Kambale (IAAC/AEIC) <kambale.katahwa@iaac-aeic.gc.ca>; Adams,Jill (IAAC/AEIC) <Jill.Adams@iaac-aeic.gc.ca>  
**Subject:** RE: EXT - RE: Notification and Request for Information - Designation Request for SMR Demonstration Project

UNCLASSIFIED - NON CLASSIFIÉ

Thanks for the update Rick.

Please note,  
 sent to Jill Adams (cc'ed here).

please ensure any correspondence is also

Thanks,  
 Joe

**From:** Gauthier, Rick <RGauthier@nbpower.com>  
**Sent:** August 23, 2022 7:20 AM

**To:** Vigder, Joseph (IAAC/AEIC) <[joseph.vigder@iaac-aeic.gc.ca](mailto:joseph.vigder@iaac-aeic.gc.ca)>

**Cc:** Harris, Claire <[CHarris@nbpower.com](mailto:CHarris@nbpower.com)>

**Subject:** RE: EXT - RE: Notification and Request for Information - Designation Request for SMR Demonstration Project

Thanks for the note Joe, we are working on the response and have a meeting scheduled internally today to review. Appreciate you reaching out, we will reach out if support is required.

Rick



Rick Gauthier  
*Licensing Manager*  
*Advanced Reactor Development Team*  
506.651.3286  
[nbpower.com](http://nbpower.com) | [energienb.com](http://energienb.com)

**From:** Vigder, Joseph (IAAC/AEIC) <[joseph.vigder@iaac-aeic.gc.ca](mailto:joseph.vigder@iaac-aeic.gc.ca)>

**Sent:** August 18, 2022 3:21 PM

**To:** Gauthier, Rick <[RGauthier@nbpower.com](mailto:RGauthier@nbpower.com)>

**Subject:** EXT - RE: Notification and Request for Information - Designation Request for SMR Demonstration Project

\*\*\* Attention: External Message / Message externe \*\*\*

UNCLASSIFIED - NON CLASSIFIÉ

Hi Rick,

Hope all is well.

Just wondering if you have had a chance to digest the letter we sent last week, and if you had any immediate questions or anything you wanted to discuss. Don't hesitate to reach out if you would like to arrange a chat.

Take care,  
Joe

**From:** Vigder, Joseph (IAAC/AEIC)

**Sent:** August 10, 2022 1:39 PM

**To:** Gauthier, Rick <[RGauthier@nbpower.com](mailto:RGauthier@nbpower.com)>

**Cc:** Harris, Claire <[CHarris@nbpower.com](mailto:CHarris@nbpower.com)>; Hayward, Andy <[AHayward@nbpower.com](mailto:AHayward@nbpower.com)>; McGathey, Andrea <[AMcGathey@nbpower.com](mailto:AMcGathey@nbpower.com)>; Adams, Jill (IAAC/AEIC)



<Jill.Adams@iaac-aeic.gc.ca>; Katahwa,Kambale (IAAC/AEIC) <kambale.katahwa@iaac-aeic.gc.ca>; Belland,Brenna (IAAC/AEIC) <Brenna.Belland@iaac-aeic.gc.ca>; Primeau,Eric (IAAC/AEIC) <Eric.Primeau@iaac-aeic.gc.ca>; Belyea, Sean <Sean.Belyea@cnscccsn.gc.ca>

**Subject:** Notification and Request for Information - Designation Request for SMR Demonstration Project

UNCLASSIFIED - NON CLASSIFIÉ

Hello Rick,

Please find attached a letter from the Impact Assessment Agency of Canada regarding a request sent to the Minister of Environment and Climate Change to designate a proposed Small Modular Reactor Demonstration Project under the *Impact Assessment Act*.

The original request sent to the Minister is also attached for your information.

Do not hesitate to reach out if you have any questions or would like to discuss the contents of the letter and the information requested.

Thank you,

Joe Vigder  
(he/him | il)

Project Manager, Atlantic Region  
Impact Assessment Agency of Canada / Government of Canada  
[joseph.vigder@iaac-aeic.gc.ca](mailto:joseph.vigder@iaac-aeic.gc.ca) / Tel : 902-229-9637

Gestionnaire de projets, région atlantique  
Agence d'évaluation d'impact du Canada / Gouvernement du Canada  
[joseph.vigder@iaac-aeic.gc.ca](mailto:joseph.vigder@iaac-aeic.gc.ca) / Tél : 902-229-9637



---

This e-mail communication (including any or all attachments) is intended only for the use of the person or entity to which it is addressed and may contain confidential and/or privileged material. If you are not the intended recipient of this e-mail, any use, review, retransmission, distribution, dissemination, copying, printing, or other use of, or taking of any action in reliance upon this e-mail, is strictly prohibited. If you have received this e-mail in error, please contact the sender and delete the original and any copy of this e-mail and any printout thereof, immediately. Your co-operation is appreciated.

Le présent courriel (y compris toute pièce jointe) s'adresse uniquement à son destinataire, qu'il soit une personne ou un organisme, et pourrait comporter des renseignements privilégiés ou confidentiels. Si vous n'êtes pas le destinataire du courriel, il est interdit d'utiliser, de revoir, de retransmettre, de distribuer, de disséminer, de copier ou d'imprimer ce courriel, d'agir en vous y fiant ou de vous en servir de toute autre façon. Si vous avez reçu le

présent courriel par erreur, prière de communiquer avec l'expéditeur et d'éliminer l'original du courriel, ainsi que toute copie électronique ou imprimée de celui-ci, immédiatement. Nous sommes reconnaissants de votre collaboration.

## Sabo,Ashley (IAAC/AEIC)

---

**From:** Adams,Jill (IAAC/AEIC)  
**Sent:** August 24, 2022 2:27 PM  
**To:** Gauthier, Rick  
**Cc:** Vigder,Joseph (IAAC/AEIC)  
**Subject:** RE: Question

**Categories:** For ATIP

UNCLASSIFIED - NON CLASSIFIÉ

Hi Rick,  
I would be happy to chat with you tomorrow – am in meetings the rest of today. Please give me a call anytime tomorrow between 9-5.  
Cheers,  
Jill

Jill Adams (she/her/elle)

A/Regional Director, Atlantic Regional Office  
Impact Assessment Agency of Canada / Government of Canada  
[Jill.adams@iaac-aeic.gc.ca](mailto:Jill.adams@iaac-aeic.gc.ca) / Tel: 709-330-6297

Directrice régionale/I, Bureau régional de l'Atlantique  
Agence d'évaluation d'impact du Canada / Gouvernement du Canada  
[Jill.adams@iaac-aeic.gc.ca](mailto:Jill.adams@iaac-aeic.gc.ca) / Tél: 709-330-6297

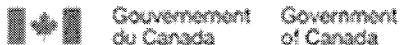

**From:** Gauthier, Rick <RGauthier@nbpower.com>  
**Sent:** Wednesday, August 24, 2022 1:56 PM  
**To:** Adams,Jill (IAAC/AEIC) <Jill.Adams@iaac-aeic.gc.ca>  
**Cc:** Vigder,Joseph (IAAC/AEIC) <joseph.vigder@iaac-aeic.gc.ca>  
**Subject:** Question

Hello Jill, Joe Vigder had offered assistance on any questions we may have on the official request letter we received on August 10, 2022. I do have a question about the financial assistance questions, if can you take a short call would you provide me a number.  
Thanks,



**Énergie NB Power**

the power of possibility  
déterminant d'énergie

Rick Gauthier  
*Licensing Manager*  
*Advanced Reactor Development Team*  
506.651.3286  
nbpower.com | energienb.com

---

This e-mail communication (including any or all attachments) is intended only for the use of the person or entity to which it is addressed and may contain confidential and/or privileged material. If you are not the intended recipient of this e-mail, any use, review, retransmission, distribution, dissemination, copying, printing, or other use of, or taking of any action in reliance upon this e-mail, is strictly prohibited. If you have received this e-mail in error, please contact the sender and delete the original and any copy of this e-mail and any printout thereof, immediately. Your co-operation is appreciated.

Le présent courriel (y compris toute pièce jointe) s'adresse uniquement à son destinataire, qu'il soit une personne ou un organisme, et pourrait comporter des renseignements privilégiés ou confidentiels. Si vous n'êtes pas le destinataire du courriel, il est interdit d'utiliser, de revoir, de retransmettre, de distribuer, de disséminer, de copier ou d'imprimer ce courriel, d'agir en vous y fiant ou de vous en servir de toute autre façon. Si vous avez reçu le présent courriel par erreur, prière de communiquer avec l'expéditeur et d'éliminer l'original du courriel, ainsi que toute copie électronique ou imprimée de celui-ci, immédiatement. Nous sommes reconnaissants de votre collaboration.

## Sabo,Ashley (IAAC/AEIC)

---

**From:** Adams,Jill (IAAC/AEIC)  
**Sent:** September 1, 2022 10:35 AM  
**To:** Gauthier, Rick; Vigder,Joseph (IAAC/AEIC)  
**Cc:** Harris, Claire; Hayward, Andy; McGathey, Andrea; Katahwa,Kambale (IAAC/AEIC); Belland,Brenna (IAAC/AEIC); Primeau,Eric (IAAC/AEIC); Belyea, Sean  
**Subject:** RE: EXT - Notification and Request for Information - Designation Request for SMR Demonstration Project

UNCLASSIFIED - NON CLASSIFIÉ

Thanks Rick.  
Best,  
Jill

Jill Adams (she/her/elle)

A/Regional Director, Atlantic Regional Office  
Impact Assessment Agency of Canada / Government of Canada  
[Jill.adams@iaac-aeic.gc.ca](mailto:Jill.adams@iaac-aeic.gc.ca) / Tel: 709-330-6297

Directrice régionale/I, Bureau régional de l'Atlantique  
Agence d'évaluation d'impact du Canada / Gouvernement du Canada  
[Jill.adams@iaac-aeic.gc.ca](mailto:Jill.adams@iaac-aeic.gc.ca) / Tél: 709-330-6297



Canada

**From:** Gauthier, Rick <RGauthier@nbpower.com>  
**Sent:** Thursday, September 1, 2022 11:07 AM  
**To:** Vigder,Joseph (IAAC/AEIC) <joseph.vigder@iaac-aeic.gc.ca>; Adams,Jill (IAAC/AEIC) <Jill.Adams@iaac-aeic.gc.ca>  
**Cc:** Harris, Claire <CHarris@nbpower.com>; Hayward, Andy <AHayward@nbpower.com>; McGathey, Andrea <AMcGathey@nbpower.com>; Katahwa,Kambale (IAAC/AEIC) <kambale.katahwa@iaac-aeic.gc.ca>; Belland,Brenna (IAAC/AEIC) <Brenna.Belland@iaac-aeic.gc.ca>; Primeau,Eric (IAAC/AEIC) <Eric.Primeau@iaac-aeic.gc.ca>; Belyea, Sean <Sean.Belyea@cnsccsn.gc.ca>  
**Subject:** RE: EXT - Notification and Request for Information - Designation Request for SMR Demonstration Project

Joe/Jill, final review of our response letter in progress, expecting to send to your team within a couple of business days.  
Rick



Rick Gauthier  
Licensing Manager  
Advanced Reactor Development Team  
506.651.3286  
nbpower.com | energienb.com

**From:** Vigder, Joseph (IAAC/AEIC) <[joseph.vigder@iaac-aeic.gc.ca](mailto:joseph.vigder@iaac-aeic.gc.ca)>

**Sent:** August 10, 2022 1:39 PM

**To:** Gauthier, Rick <[RGauthier@nbpower.com](mailto:RGauthier@nbpower.com)>

**Cc:** Harris, Claire <[CHarris@nbpower.com](mailto:CHarris@nbpower.com)>; Hayward, Andy <[AHayward@nbpower.com](mailto:AHayward@nbpower.com)>; McGathey, Andrea <[AMcGathey@nbpower.com](mailto:AMcGathey@nbpower.com)>; Adams, Jill (IAAC/AEIC) <[Jill.Adams@iaac-aeic.gc.ca](mailto:Jill.Adams@iaac-aeic.gc.ca)>; Katahwa, Kambale (IAAC/AEIC) <[kambale.katahwa@iaac-aeic.gc.ca](mailto:kambale.katahwa@iaac-aeic.gc.ca)>; Belland, Brenna (IAAC/AEIC) <[Brenna.Belland@iaac-aeic.gc.ca](mailto:Brenna.Belland@iaac-aeic.gc.ca)>; Primeau, Eric (IAAC/AEIC) <[Eric.Primeau@iaac-aeic.gc.ca](mailto:Eric.Primeau@iaac-aeic.gc.ca)>; Belyea, Sean <[Sean.Belyea@cnscccsn.gc.ca](mailto:Sean.Belyea@cnscccsn.gc.ca)>

**Subject:** EXT - Notification and Request for Information - Designation Request for SMR Demonstration Project

\*\*\* Attention: External Message / Message externe \*\*\*

UNCLASSIFIED - NON CLASSIFIÉ

Hello Rick,

Please find attached a letter from the Impact Assessment Agency of Canada regarding a request sent to the Minister of Environment and Climate Change to designate a proposed Small Modular Reactor Demonstration Project under the *Impact Assessment Act*.

The original request sent to the Minister is also attached for your information.

Do not hesitate to reach out if you have any questions or would like to discuss the contents of the letter and the information requested.

Thank you,

Joe Vigder  
(he/him | il)

Project Manager, Atlantic Region  
Impact Assessment Agency of Canada / Government of Canada  
[joseph.vigder@iaac-aeic.gc.ca](mailto:joseph.vigder@iaac-aeic.gc.ca) / Tel : 902-229-9637

Gestionnaire de projets, région atlantique  
Agence d'évaluation d'impact du Canada / Gouvernement du Canada  
[joseph.vigder@iaac-aeic.gc.ca](mailto:joseph.vigder@iaac-aeic.gc.ca) / Tél : 902-229-9637

---

This e-mail communication (including any or all attachments) is intended only for the use of the person or entity to which it is addressed and may contain confidential and/or privileged material. If you are not the intended recipient of this e-mail, any use, review, retransmission, distribution, dissemination, copying, printing, or other use of, or taking of any action in reliance upon this e-mail, is strictly prohibited. If you have received this e-mail in error, please contact the sender and delete the original and any copy of this e-mail and any printout thereof, immediately. Your co-operation is appreciated.

Le présent courriel (y compris toute pièce jointe) s'adresse uniquement à son destinataire, qu'il soit une personne ou un organisme, et pourrait comporter des renseignements privilégiés ou confidentiels. Si vous n'êtes pas le destinataire du courriel, il est interdit d'utiliser, de revoir, de retransmettre, de distribuer, de disséminer, de copier ou d'imprimer ce courriel, d'agir en vous y fiant ou de vous en servir de toute autre façon. Si vous avez reçu le présent courriel par erreur, prière de communiquer avec l'expéditeur et d'éliminer l'original du courriel, ainsi que toute copie électronique ou imprimée de celui-ci, immédiatement. Nous sommes reconnaissants de votre collaboration.

September 2, 2022

Mr. Joseph Vigder  
Project Manager, Atlantic Division  
Impact Assessment Agency of Canada  
Suite 200  
1801 Hollis St.  
Halifax, Nova Scotia  
B3J 3N4

Dear Mr. Vigder,

**Subject: Re: Designation Request for the Small Modular Reactor Demonstration Project, New Brunswick**

The purpose of this letter is to provide the requested information as outlined in Reference 1 to assist in the initial review of whether the Impact Assessment Agency of Canada will designate the New Brunswick future project.

Items requested:

- **Scope of activities, separate stand alone or single multi-phased project involving multiple SMRs**

**Context:** New Brunswick Power Corporation (NB Power) has been working with the Province of New Brunswick, Advanced Reactor Concepts (ARC) Clean Energy Canada Inc., Moltex Energy (Moltex), and the University of New Brunswick to progress the development of Small Modular Reactors (SMRs) for potential commercial deployment within NB Power property on the Point Lepreau Site. Successful completion of the Vendor Design Review (VDR) Process Phase I and II, along with technical and financial viability, could result in commercial demonstrations of one ARC unit and/or one Moltex SSR-W unit with grid reserve, within the existing property. This could be followed by a subsequent deployment of additional units to be in-service prior to the retirement of the Point Lepreau Nuclear Generating Station (PLNGS); however, this is speculative at this point in time.



- We are currently in a pre-project phase of a single commercial demonstration unit ARC design. The ARC-100 is a sodium-cooled fast reactor that will generate 286 - 429 Mwt to yield 100 to 150 Mwe (electrical net output). ARC has completed Phase I of the VDR process (with the Canadian Nuclear Safety Commission (CNSC)) and has begun Phase II.
- The commercial demonstration unit experience will be used as input for decisions on future units.
- A Moltex Unit would use a separate technology and Moltex is in conceptual design and research and development; whereas ARC is more advanced in its design. Such units would be proposed by a separate vendor and require separate review and approval by the CNSC; therefore, have separate approval timelines. The two vendors (ARC and Moltex) are completely separate, and the projects are not interdependent.
- Any future ARC units and/or a Moltex unit are currently not planned or funded.
- **Role of NBP roles and responsibilities and relationships between NBP and vendors, third parties**
  - NBP will be the operator and license holder of the ARC unit.
  - ARC Energy is the technology developer, engineering support for design with third party engineering organizations.
- **Total number of SMRs proposed and Mwt and relationship between proposed SMRs**
  - One ARC commercial demonstration unit with a thermal output between 286-429 Mwt.
- **Anticipated requirements for the management, storage or disposal of irradiated nuclear fuel or nuclear waste**
  - The ARC design has a 20-year fuel load, after the 20 years the fuel will be stored internally in the periphery of the reactor vessel. The used fuel will subsequently be moved to onsite dry-cask storage. Work is underway with ARC Energy Canada and the Nuclear Waste Management Organization regarding used fuel disposal in the Deep Geological Repository.
- **Current activities underway and estimated timelines for planning approval, construction, operation and decommissioning**
  - Site evaluation activities as per CNSC *REGDOC 1.1.1. Site Evaluation and Site Preparation for New Reactor Facilities* has begun with an application for a License to Prepare Site for a single unit on June 30, 2023. This application submission will officially start the project and the environmental assessment that is required before a license to prepare site can be issued by the Canadian Nuclear Safety Commission. License applications for construction, and operation would follow in December 2024 and January 2027.
  - Baseline characterization and assessment of the biophysical and human environment in accordance with the New Brunswick *Environmental Impact Assessment Regulation* 87-83 under the *Clean Environment Act* and the Tailored Impact Statement Guidelines (TISGs) Template for Designated Projects Subject to the *Impact Assessment Act* and the *Nuclear Safety and Control Act*. The environmental impact assessment (EIA) documentation will be submitted to the New Brunswick Department of Environment and Local Government on June 30, 2023, under the Comprehensive Review Process. The estimated timeline for this EIA process is 36 months.

- **Anticipated regulatory approvals (Federal, provincial, municipal)**
  - NB Power has consulted with the province to confirm that the ARC project is listed in Schedule A of the EIA Regulation (i.e., it would have “a production rating of 3 MW or more”); therefore, the proponent must prepare an EIA and formally register the project with the NBDELG. Since the ARC SMR is subject to provincial EIA legislation, the CNSC is expected to act as a technical advisor and is an active participant at all stages of the EIA process. The CNSC will retain decision-making authority on licensing matters, and use the information gathered in the EIA process to inform its licensing decision under the NSCA.
  - Since the ARC SMR will produce between 286-429 MWth, and the Physical Activities Regulations set a threshold of >900 MWth on an existing licensed site for site preparation, construction, operation and decommissioning of one or more new nuclear reactors. NB Power does not anticipate that a federal IA is required for this proposed project.

The following is a list of potential permits or approvals. Please refer to Table 2 for more details.

- CNSC License to Prepare Site, license to construct and license to operate.
- Potential additional federal approvals under the following legislation:
  - *Fisheries Act,*
  - *Species at Risk Act,*
  - *Canadian Navigable Waters Act,*
  - *Canada Shipping Act,*
  - *Migratory Birds Convention Act, 1994,*
- Provincial approvals:
  - EIA under the Comprehensive Review Process
  - Approvals to Operate/Construct,
  - Wetland and Watercourse Alteration,
  - vehicle load/mass approvals per the *NB Motor Vehicle Act*
- Local approvals: Re-zoning, Building, Blasting
- **NBP views on any proposed or potential future activities are described on project list and any other information relevant to IAA review**
  - NBP is working with Moltex Energy on a potential future unit. The Moltex Energy Stable Salt Reactor – Wasteburner (SSR-W or SSR-W300) would generate 750 MWth to yield 300 Mwe. It will use a Molten Salt Fast Reactor in which spent nuclear fuel will be recycled to produce fuel suitable for a fast reactor, along with a CANDU 6 used fuel reprocessing facility. Moltex has completed its VDR Phase I process and is working to move on to VDR Phase II and then to the application for the necessary licences.

- Moltex would be a separate project that will require an impact assessment for fuel recycling as it would fall within the projects listed in the Physical Activities Regulations (i.e., the construction, operation and decommissioning of one of fuel processing/reprocessing with a production capacity of 100 t/year or more or use in a quantity greater than 1015 Bq per calendar year of nuclear substances with a half-life greater than one year, other than uranium, thorium or plutonium). It is understood that this separate project would be considered a Designated Project and it is anticipated that an IA could be initiated when the research and development is sufficiently underway.
- It is understood that nuclear projects to be assessed under the IAA are subject to an “integrated impact assessment” that is carried out by a review panel. A memorandum of understanding (MOU) between the CNSC and the IAAC outlines the roles and responsibilities of each organization and helps guide collaboration into conducting integrated IAs under the IAA. In addition, since the project would also require an EIA by the province of NB and given the need for a review panel, it is expected that the IAAC, the CNSC and the Province of NB would develop a form of project-specific Cooperation Agreement or a Joint Review Panel Agreement outlining the review process and the terms of reference for the review panel so that the review panel arrangement would aim to meet the process requirements of the Province of NB, and outline decision making authority/roles for all parties.
- As mentioned above, the ARC and Moltex demonstration units are being designed by separate vendors, which require separate approvals from the CNSC. They are not interdependent.

**Additional requests in letter that may be requested or if available submit with this letter:**

- A full assessment of effects, including input from public and Indigenous consultation, will be completed per the NB EIA process, which will involve federal regulators such as the CNSC and will comply with the spirit of the federal TISG template. The following provides some preliminary information. In addition, annual monitoring reports at Point Lepreau and CNSC environmental monitoring reports for licensing renewal could provide evidence to many of these statements.

**Table 1: Potential Effects to Areas of Federal Interest**

<b>Federal Interests</b>	<b>Potential Effect Discussion</b>
<p><b>Potential adverse effects to fish/fish habitat, migratory birds and species at risk</b></p>	<ul style="list-style-type: none"> <li>● Potential for interaction with fish depends on cooling water &amp; intake (impingement &amp; entrainment); however, effects would not be significant at a population level. Such a design would be planned in consultation with DFO and would be mitigated and offset</li> </ul> <p>Potential interaction with birds as a result of cooling towers or lighting is possible.</p> <ul style="list-style-type: none"> <li>● The site is co-existing with migratory birds, SAR habitat etc. currently. Effects minimized as site is not a main flight route</li> <li>● There is a lot of operational experience and effects can be mitigated, e.g., with compliance with general breeding bird windows and engineering controls to avoid impacts through design.</li> </ul>

<p><b>Potential adverse changes to the environment that would occur on federal land and lands outside NB or Canada</b></p>	<ul style="list-style-type: none"> <li>• No federal lands or lands outside of NB or Canada will be directly impacted.</li> <li>• Potential Impacts are expected to be the same as currently present.</li> <li>• Potential indirect impacts relating to accidents and malfunctions will be managed through the CNSC licensing process and safety will be built into the design process (e.g., units shut themselves down).</li> </ul>
<p><b>Potential greenhouse gas emissions</b></p>	<ul style="list-style-type: none"> <li>• Emissions anticipated just during construction</li> <li>• Backup power e.g., diesel generators would be the main source of emissions during operations,</li> <li>• Impacts are positive – the purpose is to support GHG reduction.</li> <li>• The site is currently below thresholds</li> </ul>
<p><b>Potential adverse impacts resulting from any changes to the environment on Indigenous peoples</b></p>	<ul style="list-style-type: none"> <li>• No such changes are anticipated</li> <li>• The site is existing, no current traditional land use</li> <li>• Past development has already impacted the site</li> </ul>
<p><b>Potential adverse impacts on the rights of Indigenous peoples</b></p>	<ul style="list-style-type: none"> <li>• This is an established nuclear facility, and it is a compatible land use.</li> <li>• The proposed construction will not occur outside the NB Power property, with a possible exception being aquatic work, which if required, would be planned in consultation with DFO, Transport Canada and NBDELG, in consultation with Indigenous groups.</li> </ul>
<p><b>Potential adverse effects to the environment, or to health, social or economic conditions.</b></p>	<ul style="list-style-type: none"> <li>• Positive change economically for those that are partners in the project, engaging early for training (work and supply chain), jobs, etc.</li> <li>• The EIA will consider potential for impacts to marginalized peoples, including women (scoping socio-economic impact assessment to study GBA+ issues)</li> <li>• Adverse health impacts are not anticipated and will be considered in the EIA.</li> <li>• There is an opportunity for education about nuclear impacts.</li> </ul>

**In particular the IAA requests available information regarding:**

- 1. Key project activities, maps and layouts of the location of project components, land tenure and zoning**
  - A map of the facility (Attachment 1) is included in this letter. The proposed Point Lepreau site is owned by NB Power. Currently site evaluation activities are under way as per *REGDOC 1.1.1*, no site preparation activities will be conducted until a License to Prepare Site is issued by the CNSC.
  
- 2. Any Federal financial assistance that would be required or has already been attained or provided**
  - NB Power has received financial assistance from ACOA (Project 217643) for preparation activities associated with the deployment of SMR technologies in New Brunswick. NB Power is seeking additional Federal assistance through the following:
  - Access to a portion of the newly established \$250M Clean Electricity Fund that is being set up to support pre-development activities for clean electricity projects of national significance. Initial discussions have been held but no formal application has been submitted.
  - Potential project execution funding support from the Canadian Infrastructure Bank. Initial discussions have been held with additional discussions.
  - Other funding and financial strategies are being explored with the federal government through nuclear industry executives.

One NB SMR technology vendor has received SIF funding and is expected to request additional funding. The other NB SMR technology vendor has submitted a SIF Application which is currently being processed.

- 3. For each regulator approval that would be required provide**
  - i. Name of license, permit, authorization or approval, legislative framework and responsible jurisdiction**
    - Please see Table 2 below.

Table 2: Anticipated Regulatory Requirements

Legislative Framework	Responsible Jurisdiction	Name of license, permit, authorization or approval	Status of Attaining the Regulatory Approvals	Whether it would involve assessments of any of the effects	Whether public and or Indigenous consultation would be required
<b>Federal</b>					
<i>Nuclear Safety and Control Act (NSCA) and associated Regulations</i>	Canadian Nuclear Safety Commission (CNSC)	All phases of Canadian Nuclear Safety Commission Licensing, i.e.,: <ul style="list-style-type: none"> <li>• License to Prepare Site (LTSPS);</li> <li>• License to Construct;</li> <li>• License to Operate;</li> <li>• License to Decommission</li> </ul>	<ul style="list-style-type: none"> <li>• LTSPS application June 2023</li> <li>• License to Construct application: December 2024</li> <li>• License to Operate application: January 2027</li> <li>• License to Decommission : TBD</li> </ul>	Assessments of effects are required in a graded approach for each of the four licensing phases for Nuclear Power Plants as per the requirements set out in License Application Guides <ul style="list-style-type: none"> <li>• REGDOC 1.1.1 Site Evaluation and Site Preparation for New Nuclear Power Plants,</li> <li>• REGDOC 1.1.2 License Application Guide: License to Construct a Reactor Facility,</li> <li>• REGDOC 1.1.3 License Application Guide: License to Operate a Nuclear Power Plant and</li> <li>• REGDOC 1.1.4 License Application Guide: License to Decommission Reactor Facilities</li> </ul>	<p>Yes public and Indigenous engagement is required and began in 2018.</p> <p>Crown consultation requirements are a function of the CNSC on behalf of the federal government and it is anticipated that some procedural aspects may be delegated to NB Power.</p>
<i>Fisheries Act</i>	Fisheries and Oceans Canada (DFO)	Letter of Advice or Authorization (if required)	Requirements to be confirmed during ELA process	Yes. The <i>Fisheries Act</i> prohibits causing the death of fish and the harmful alteration, disruption or destruction (HADD) of fish habitat. For works in or near water where impacts to fish and fish habitat cannot be avoided, a DFO Request for Review may be required to determine requirements. DFO is expected to review the proposed Project to identify the potential risks to the conservation and protection of fish and fish habitat.	<p>Yes. DFO is responsible for the duty to consult, and where appropriate accommodate Indigenous peoples of Canada in relation to Fisheries Act or Species at Risk Act regulatory decisions that may have the potential to impact Indigenous and treaty rights. DFO's Fisheries Protection Program suggests providing a summary of any:</p> <ul style="list-style-type: none"> <li>• public engagement activities and outcomes; and</li> <li>• Indigenous engagement activities and outcomes.</li> </ul>

				<p>Similarly, a request for review may be required under SARA if the Project may have adverse effects to an aquatic species at risk or its habitat. If death of fish or a HADD of fish habitat can be avoided, a Letter of Advice for the Project may be issued stating that the Project can proceed.</p> <p>If death of fish or a HADD of fish habitat will likely result, the Project will be required to obtain an authorization as per Paragraph 34.4(2)(b) or 35(2)(b) of the <i>Fisheries Act</i> Regulations, with or without SARA conditions.</p>	<p>This will help DFO determine if there is a duty to consult with Indigenous peoples relatively early in the review of the application.</p>
<i>Species at Risk Act</i>	DFO and/or ECCC	Letter of Advice or Authorization (if required)	Requirements to be confirmed during EIA process	<p>Yes. SARA requires the protection of species at risk and their habitats on federal crown lands (or other lands per Ministerial order). If federally-listed wildlife species or habitat may be impacted, authorization may be required.</p>	<p>Yes. If a permit application is required, applicants are asked to provide any information they may have on whether asserted Indigenous rights could be affected and any consultation or engagement work that they have done with Indigenous peoples. This will help determine if there is an additional requirement to meet the duty to consult relatively early in the process.</p>
<i>Migratory Birds Convention Act</i> and regulations	Environment and Climate Change Canada (ECCC)	Compliance with the Act and regulations	Requirements to be confirmed during EIA process	<p>Assessment will be completed as part of the EIA process, including baseline studies for potential habitat, and if so, a commitment to complete non-intrusive breeding bird surveys prior to construction.</p>	N/A
<i>Canadian Navigable Water Act</i>	Transport Canada	Navigation Protection Program approval (if required)	Requirements to be confirmed during EIA process	<p>The Act applies to projects that will interfere with navigation in Canadian navigable waters. "Major" works that are likely to substantially interfere with navigation will require approval from Transport Canada; however, "Minor" works may not require an application as long as they comply with legal requirements.</p>	<p>Yes. The Act includes a process to notify the public and help resolve conflicts about works on navigable waters. This process allows Canadians to have a say in projects that affect their right to travel on a waterway.</p>

					In addition, if the work a legal duty to consult with Indigenous groups, the proponent may need to provide detailed information necessary to ensure consultations are adequate.
<i>Canada Shipping Act and regulations</i>	Transport Canada		Requirements to be confirmed		
<b>Provincial</b>					
<i>Clean Environment Act - Environmental Impact Assessment Regulation (NB Reg 87-83)</i>	New Brunswick Department of Environment and Local Government (NBDELG)	NB EIA Comprehensive Review Decision (approval)	EIA Registration (Comprehensive Review) submission: June 2023  Anticipated approval (Decision): September 2026	Potential adverse effects of each of the items listed will be addressed in the EIA following assessment requirements outlined in the NB EIA Regulation. NB Power has committed to complete the provincial EIA in compliance with the spirit of the federal Tailored Impact Statement Guidelines (TISGs) Template for Designated Projects Subject to the <i>Impact Assessment Act</i> , including completion of a Sustainability and Well-being Assessment and Indigenous Knowledge/Indigenous Resource and Land Use studies.	Provincial Crown consultation is also required under the EIA Regulation. We have developed an Indigenous Inclusion Guide which has been shared extensively with all Indigenous Organizations and Communities. <i>More information is provided after this table.</i>
<i>Clean Water Act - Watercourse and Wetland Alteration Regulation (NB Reg 90-80) -</i>	NBDELG	Watercourse and Wetland Alteration (WAWA) Permit	Requirements to be confirmed during EIA process	Potential effects to watercourses and wetlands would be assessed	
<i>Clean Environment Act - Water Quality Regulation (NB Reg 82-126) -</i>	NBDELG	Approval to Operate Water Quality	Requirements to be confirmed during EIA process	Potential effects to water quality would be assessed	
<b>Municipal</b>					
<i>Community Planning Act</i>		Building Permit	TBD		



The following provides more details about NB Powers Indigenous engagement and inclusion program.

- The Indigenous Inclusion Guide is based on building mutually beneficial relationships with Indigenous communities. This guide is a continually evolving document that continues to be informed and evolved as input is received through discussions and collaborations with community leadership, members and representative organizations. Our aim is to have all communities included in this opportunity.
- The Indigenous Inclusion Guide is built on five (5) key pillars:
  1. Leadership
  2. Relationships
  3. People and Culture
  4. Economic Empowerment
  5. Environmental Stewardship

The principles underlying the guide are:

- Listening with open minds
- Creating an environment of collaboration
- Delivering on commitments
- Working toward a mutually beneficial clean energy future

Some examples of specific activities that are currently underway are:

- Indigenous Inclusion Steering Committee (includes NB members from the National SMR Action Plan Indigenous Advisory Council and Leadership Table as well as a lead from Wolasteqey Nation of NB)
- SMR Information Sessions have been held in most Indigenous Communities at least once and in some cases many times.
- Indigenous Youth Strategy has been developed and youth camps and station tours have been completed
- Indigenous Employment Strategy is being developed with *Indigenous Works Canada*
- SMR Program participates in the Indigenous Clean Energy (ICE) Generation Power Program
- Equity discussions are occurring with several Indigenous Communities
- Indigenous focused Procurement /Supply Chain workshops have occurred with more planned for future
- Indigenous Knowledge/ Indigenous Resource and Land Use Studies are underway
- Environmental Studies are being scoped through an Indigenous lens and the Aquatic and Terrestrial Studies are Indigenous Led.
- Sustainability, Well-Being, Archeological, Marine, Climate Change studies all have Indigenous inclusion

Concerns center around safety and waste management and we share those concerns and that is why we are working with advanced reactor technology. The ARC – 100 reactor generates far less waste.

- **Identify whether any license, permit, authorization or approval listed above would address the following.**
  - i. Cumulative effects, effects of potential accidents or malfunctions
    - All of the four CNSC licenses for NBP will consider cumulative effects and potential accidents and malfunctions.
    - The Provincial EIA will address cumulative effects, potential accidents and malfunctions, alternatives to/means, long-term management of waste and non-proliferation. The EIA will follow the spirit of the federal guidance (CEAA 2012) regarding cumulative effects assessment, and mitigation and monitoring will take such effects into account.
    - Should a second demonstration unit be proposed in the future (e.g., a Moltex unit), it is expected to trigger a federal impact assessment process; which is anticipated to require a fulsome consideration of potential cumulative effects, including consideration of the ARC unit, should it be approved and under construction or operational at that time.
  
- 4. **For all federal licenses, permits, authorizations, approvals, and/or financial assistance that has or may be provided for the Project, describe any anticipated adverse direct or incidental effects (including changes to health, social and economic conditions) that may occur as a result.**
  - Please refer to Tables 1 and 2.
  
- 5. **What steps have you taken to consult with the public? What steps do you plan to undertake during all phases of the Project?**
  - We have developed a public engagement strategy with the primary goal to ensure information related to the health, safety, and security of the persons and environment, the potential benefits in terms of economy and climate change action, as well as any other topics associated with SMRs are effectively communicated to Indigenous rights-holders and public stakeholders.

Our Engagement Strategy and Plan has five phases to support the development of an Advanced Nuclear Program in New Brunswick:

- Phase 1 – Pre-Project Engagement
- Phase 2 – Pre-Licensing
- Phase 3 – During Licensing Process and EA
- Phase 4 – During Project Implementation
- Phase 5 – Post Project Engagement

Currently, we are in Phase 1 of this plan.

We recognize that each group with an interest in a potential advanced SMR project requires and expects different types of information and those expectations must be met in varying ways. We aim to fully understand each right-holder's and stakeholder's stated purposes, as well as their interests, concerns, information needs, and expectations of involvement in decision-making. We also consider the communication and engagement techniques best suited to each person or group. We then incorporate the lessons we learn into our overall strategy, which we will improve on as engagement activities evolve.

Some examples of specific activities that are currently underway are:

- Providing information to the general public about advanced SMRs through various accessible channels, including our company websites, social media, print materials, in-person events, and virtual presentations
- Engaging with local communities near the Point Lepreau Nuclear Generating Station through presentations at Community Liaison Committee meetings and company booths at open houses
- Partnership with the New Brunswick Department of Education's Centre of Excellence for Energy to facilitate learning opportunities for youth and educators, including presentations, classroom visits, and plant tours
- Partnerships with post-secondary education institutions for nuclear engineering research and development and program and skills development
- Exploring partnership and mentorship opportunities between existing and new suppliers to advance the advanced SMR sector.

We track public concerns related to advanced SMRs through the media, surveys, and direct correspondence. Primary concerns relate to safety, waste management, and cost. We strive to ensure our communications with the public address these concerns and provide information to demonstrate that the advanced reactor designs that we are developing in the province will address these issues.

6. **Are you aware of any public concerns in relation to the project? If yes, provide an overview of the key issues and the way in which (in general terms) you intend to address these issues.**
  - In addition to positive public feedback, NB Power is aware of public concerns as identified in interventions from recent re-licensing activities for PLNGS, community engagement, Indigenous engagement and the CRED-NB submission to request designation.
7. **Do you have any other comments in relation to environmental effects or impacts to the public or Indigenous peoples and how you intend to address and manage those?**
  - The project will displace electricity currently generated by the Belledune coal fired generating station in New Brunswick and will significantly reduce related green-house gas emissions. This in turn will assist New Brunswick and Canada to meet the national net-zero target by 2050.
8. **Explain your views on whether the Project should be designated under the IAA.**
  - The future NBP commercial demonstration ARC unit should not be designated under the IAA for the following reasons.
    - i. The future project will be below the threshold for initiation as described on the project list section 27-29 of the Act
    - ii. The project will not be on federal land
    - iii. The ARC SMR technology is not new, this technology was successfully operated in Argonne National Lab from 1965 to 1994, a 20 Mwe (62 Mwt) experimental breeder reactor that has been upscaled to the ARC-100.

Mr. Joseph Vigder  
September 2, 2022

Page 13 of 13

- iv. We will be addressing federal environmental requirements in provincial jurisdiction (as guided by IAAC's TISG template) with the CNSCs involvement, and through consultation and permitting with federal authorities, as required. This will include consideration of potential impact to Indigenous rights and other impacts that may occur as a result of changes to the environment.

If you require additional information, please contact Rick Gauthier, Licensing Manager, Advanced Reactor Development Program at 506-651-3286 or rgauthier@nbpower.com.

Sincerely,

Rick Gauthier  
Advanced Reactor Development Licensing Manager  
NB Power

AH/RG/rg

**cc:** C. Harris, A. Hayward, A. McGathey (NB Power)  
J. Adams, K. Katahwa, B. Belland, E. Primeau, (Impact Assessment Agency of Canada)  
Sean Belyea (Canadian Nuclear Safety Commission)

**References:**

1. Letter: to Mr. Rick Gauthier from Mr. Joseph Vigder "Designation Request for the Small Modular Reactor Demonstration Project, New Brunswick", 2022-08-10.

**Attachments:**

1. Map of the ARC-100 Facility

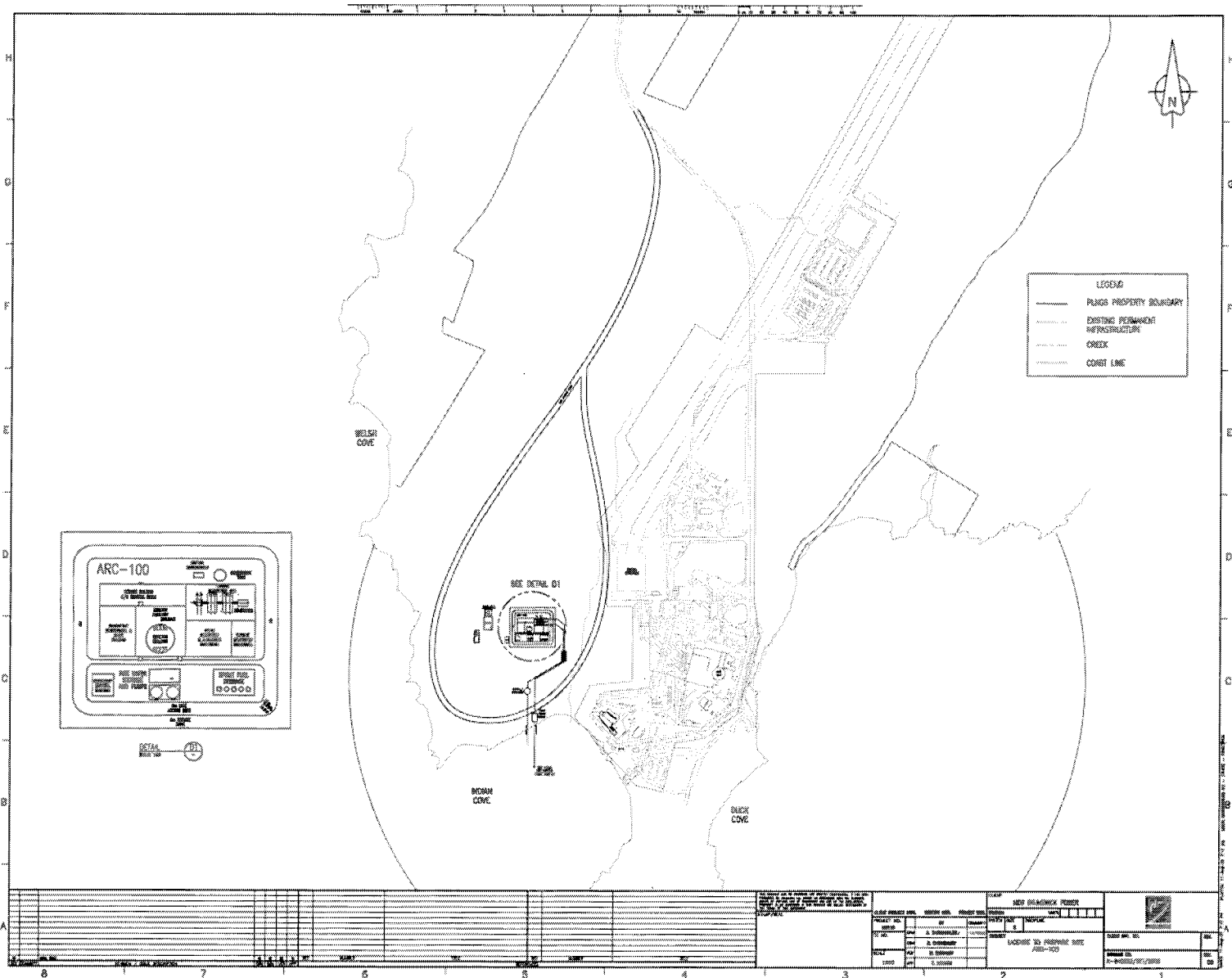

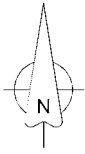
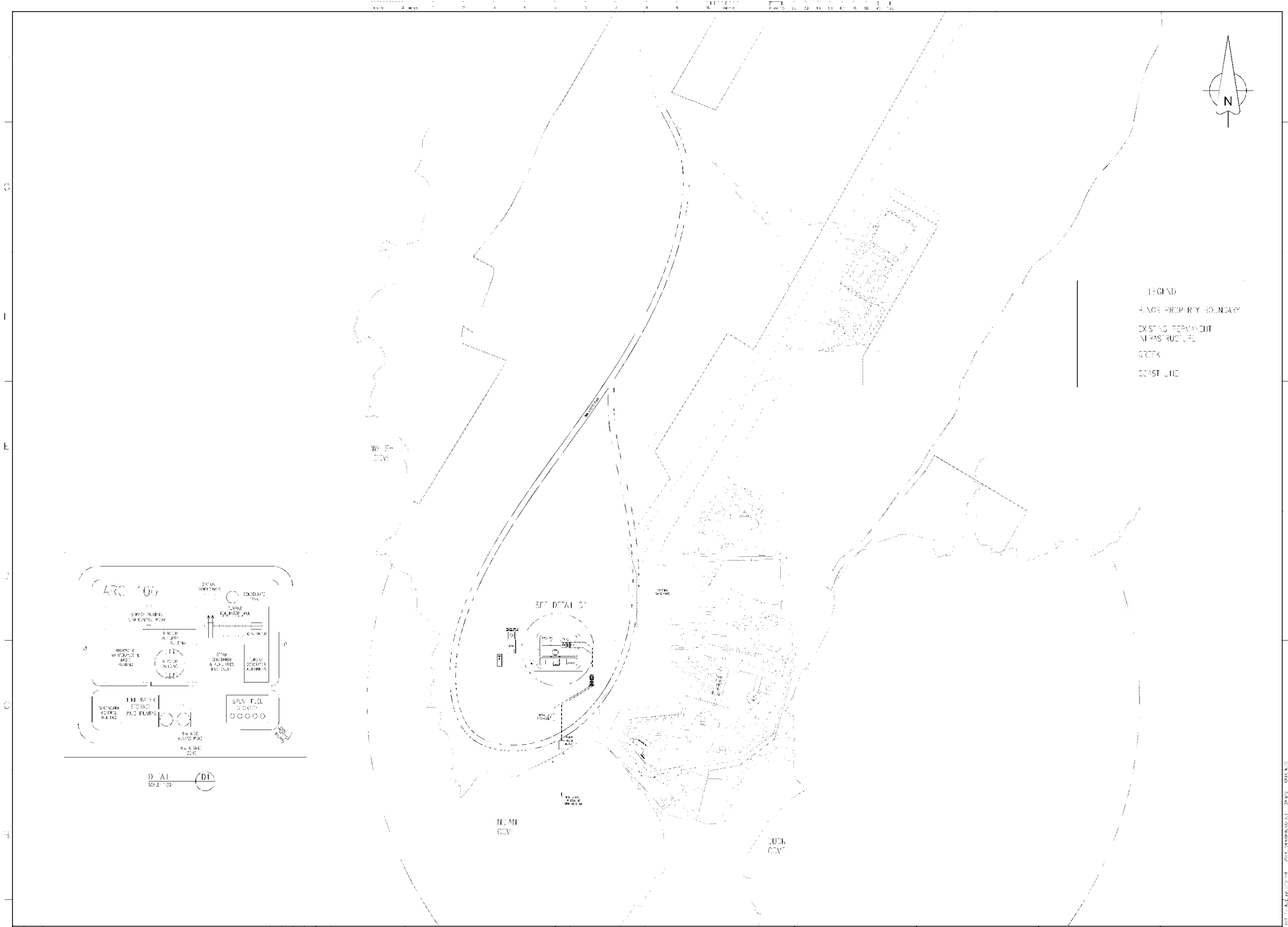

LEGEND  
 HANGS PROPERTY BOUNDARY  
 EXISTING DEPARTMENT  
 STRUCTURE  
 DATA  
 COST LINE

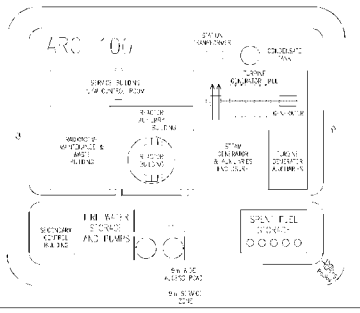

D A1  
 SCALE 1:50

<p>THESE PLANS AND SPECIFICATIONS ARE THE PROPERTY OF THE ENGINEER. ANY REUSE OR REPRODUCTION OF ANY PART OF THESE PLANS WITHOUT THE WRITTEN PERMISSION OF THE ENGINEER IS STRICTLY PROHIBITED. THE USER AGREES TO HOLD THE ENGINEER HARMLESS FROM ANY AND ALL CLAIMS, DAMAGES, LOSSES AND EXPENSES, INCLUDING REASONABLE ATTORNEY'S FEES, ARISING FROM OR OUT OF THE USE OF THESE PLANS.</p>											
<p>PROJECT NO. 2011-01</p>				<p>CLIENT: [Name]</p>				<p>DATE: 10/20/2011</p>			
<p>DESIGNER: [Name]</p>				<p>CHECKER: [Name]</p>				<p>DATE: 10/20/2011</p>			
<p>SCALE: 1:50</p>				<p>PROJECT: [Name]</p>				<p>NO. OF SHEETS: 10</p>			
<p>PROJECT NO. 2011-01</p>				<p>CLIENT: [Name]</p>				<p>DATE: 10/20/2011</p>			
<p>DESIGNER: [Name]</p>				<p>CHECKER: [Name]</p>				<p>DATE: 10/20/2011</p>			
<p>SCALE: 1:50</p>				<p>PROJECT: [Name]</p>				<p>NO. OF SHEETS: 10</p>			



000174

**Sabo,Ashley (IAAC/AEIC)**

---

**From:** Gauthier, Rick <RGauthier@nbpower.com>  
**Sent:** September 8, 2022 9:09 AM  
**To:** Vigder,Joseph (IAAC/AEIC)  
**Subject:** RE: EXT - Notification and Request for Information - Designation Request for SMR Demonstration Project

**Categories:** For ATIP

Joe, Thanks for the note.

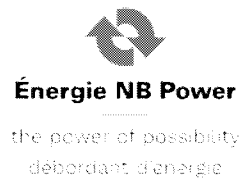

Rick Gauthier  
*Licensing Manager*  
*Advanced Reactor Development Team*  
 506.651.3286  
 nbpower.com | energienb.com

**From:** Vigder,Joseph (IAAC/AEIC) <joseph.vigder@iaac-aeic.gc.ca>  
**Sent:** September 08, 2022 8:56 AM  
**To:** Gauthier, Rick <RGauthier@nbpower.com>  
**Subject:** RE: EXT - Notification and Request for Information - Designation Request for SMR Demonstration Project

UNCLASSIFIED - NON CLASSIFIÉ

Hi Rick,

and just wanted to acknowledge receipt of NB Power's submission. If we have any further questions, I will be in touch.

Thanks,  
 Joe

**From:** Gauthier, Rick <RGauthier@nbpower.com>  
**Sent:** September 6, 2022 12:28 PM  
**To:** Vigder,Joseph (IAAC/AEIC) <joseph.vigder@iaac-aeic.gc.ca>; Adams,Jill (IAAC/AEIC) <Jill.Adams@iaac-aeic.gc.ca>  
**Cc:** Harris, Claire <CHarris@nbpower.com>; Hayward, Andy <AHayward@nbpower.com>; McGathey, Andrea <AMcGathey@nbpower.com>; Katahwa,Kambale (IAAC/AEIC) <kambale.katahwa@iaac-aeic.gc.ca>; Belland,Brenna (IAAC/AEIC) <Brenna.Belland@iaac-aeic.gc.ca>; Primeau,Eric (IAAC/AEIC) <Eric.Primeau@iaac-aeic.gc.ca>; Belyea, Sean <Sean.Belyea@cnsccsn.gc.ca>; Plummer, Brett <BPlummer@nbpower.com>; Woodworth, Wayne <WWoodworth@nbpower.com>;

Robinson, Rose M <[RRobinson@nbpower.com](mailto:RRobinson@nbpower.com)>

**Subject:** RE: EXT - Notification and Request for Information - Designation Request for SMR Demonstration Project

Hello Joe/Jill, attached is our electronic response letter for the requested information from the Impact Assessment Agency.

Please do not hesitate to contact me with any further inquiries.



Rick Gauthier  
*Licensing Manager*  
*Advanced Reactor Development Team*  
506.651.3286  
nbpower.com | energienb.com

**From:** Vigder, Joseph (IAAC/AEIC) <[joseph.vigder@iaac-aeic.gc.ca](mailto:joseph.vigder@iaac-aeic.gc.ca)>

**Sent:** August 10, 2022 1:39 PM

**To:** Gauthier, Rick <[RGauthier@nbpower.com](mailto:RGauthier@nbpower.com)>

**Cc:** Harris, Claire <[CHarris@nbpower.com](mailto:CHarris@nbpower.com)>; Hayward, Andy <[AHayward@nbpower.com](mailto:AHayward@nbpower.com)>; McGathey, Andrea <[AMcGathey@nbpower.com](mailto:AMcGathey@nbpower.com)>; Adams, Jill (IAAC/AEIC) <[Jill.Adams@iaac-aeic.gc.ca](mailto:Jill.Adams@iaac-aeic.gc.ca)>; Katahwa, Kambale (IAAC/AEIC) <[kambale.katahwa@iaac-aeic.gc.ca](mailto:kambale.katahwa@iaac-aeic.gc.ca)>; Belland, Brenna (IAAC/AEIC) <[Brenna.Belland@iaac-aeic.gc.ca](mailto:Brenna.Belland@iaac-aeic.gc.ca)>; Primeau, Eric (IAAC/AEIC) <[Eric.Primeau@iaac-aeic.gc.ca](mailto:Eric.Primeau@iaac-aeic.gc.ca)>; Belyea, Sean <[Sean.Belyea@cnsccsn.gc.ca](mailto:Sean.Belyea@cnsccsn.gc.ca)>

**Subject:** EXT - Notification and Request for Information - Designation Request for SMR Demonstration Project

\*\*\* Attention: External Message / Message externe \*\*\*

UNCLASSIFIED - NON CLASSIFIÉ

Hello Rick,

Please find attached a letter from the Impact Assessment Agency of Canada regarding a request sent to the Minister of Environment and Climate Change to designate a proposed Small Modular Reactor Demonstration Project under the *Impact Assessment Act*.

The original request sent to the Minister is also attached for your information.

Do not hesitate to reach out if you have any questions or would like to discuss the contents of the letter and the information requested.

Thank you,

Joe Vigder



(he/him | il)

Project Manager, Atlantic Region  
Impact Assessment Agency of Canada / Government of Canada  
[joseph.vigder@iaac-aeic.gc.ca](mailto:joseph.vigder@iaac-aeic.gc.ca) / Tel : 902-229-9637

Gestionnaire de projets, région atlantique  
Agence d'évaluation d'impact du Canada / Gouvernement du Canada  
[joseph.vigder@iaac-aeic.gc.ca](mailto:joseph.vigder@iaac-aeic.gc.ca) / Tél : 902-229-9637

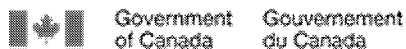

Canada

---

This e-mail communication (including any or all attachments) is intended only for the use of the person or entity to which it is addressed and may contain confidential and/or privileged material. If you are not the intended recipient of this e-mail, any use, review, retransmission, distribution, dissemination, copying, printing, or other use of, or taking of any action in reliance upon this e-mail, is strictly prohibited. If you have received this e-mail in error, please contact the sender and delete the original and any copy of this e-mail and any printout thereof, immediately. Your co-operation is appreciated.

Le présent courriel (y compris toute pièce jointe) s'adresse uniquement à son destinataire, qu'il soit une personne ou un organisme, et pourrait comporter des renseignements privilégiés ou confidentiels. Si vous n'êtes pas le destinataire du courriel, il est interdit d'utiliser, de revoir, de retransmettre, de distribuer, de disséminer, de copier ou d'imprimer ce courriel, d'agir en vous y fiant ou de vous en servir de toute autre façon. Si vous avez reçu le présent courriel par erreur, prière de communiquer avec l'expéditeur et d'éliminer l'original du courriel, ainsi que toute copie électronique ou imprimée de celui-ci, immédiatement. Nous sommes reconnaissants de votre collaboration.

Notes - Meeting w CNSC

Date

- NB has provided \$ for "research cluster"

- June 2023 to be submitting licence to prepare site

- Fuel recycling for Moltex SMR  
• Fuel facility would trigger IA

- NB Power also signed deal w Gearing for hydrogen facility supplied potentially w ARC reactors

- Pump house → separate, additional one required  
• ARC reactor  
• Marine works?  
• Not in licensed boundaries?

- Licensed Boundaries of Port Lepreau  
• ARC would be within licensed boundary  
• BUT ARC will be a new licensed facility

- Spent fuel storage for 10 years to "cool off" then transfer to cask storage for longer term  
• Potential deep geological storage  
• Storage on-site will be part of operating licence

Meeting notes  
(Micheline  
Savard)  
Sept 12, 2022

MS TEAMS - CNSC

3:30 Sean Belyea, Joe V, Mich

Licensing officer  
No official submission at this stage

ARC 2023 < 900 MW  
JSP # MelTex + waste treatment facility

Class 1A exists fuel facility  
1km exclusion zone

separate license

Accidents/malfunctioning scenarios.

waste management

20yr cycle for fresh water  
10yr cycle for salt pool

Storage of waste is part of operating license

crisis consultation

Pf. Japan, active agreement  
public engagement component

uranium, water, & waste fuel in Canada  
not manufacturing fuel (come from US  
public subscription)

North Sea - need to get

Check files that are on the original  
request.

ENSC - agreement with some JGs

NS come outside of a secondary loop  
some will



- ~~1/15~~ CNSC has lots on Indigenous consultation stuff

- Not much consultation w NS groups
- A: M → primary, secondary zones  
↳ NS outside secondary zone

**Sabo,Ashley (IAAC/AEIC)**

---

**Subject:** RE: EXT - Notification and Request for Information - Designation Request for SMR Demonstration Project  
**Location:** Microsoft Teams Meeting

**Start:** Mon 2022-09-12 2:30 PM  
**End:** Mon 2022-09-12 3:30 PM  
**Show Time As:** Tentative

**Recurrence:** (none)

**Organizer:** Belyea, Sean

**Categories:** For ATIP

Hi Joe,

I'm free anytime after 2:30 on Monday. Let me know if this time works for you and we can discuss.

Sean

-----  
h (IAAC/AEIC) <[joseph.vigder@iaac-aeic.gc.ca](mailto:joseph.vigder@iaac-aeic.gc.ca)>  
2022 2:03 PM

- Notification and Request for Information - Designation Request for SMR Demonstration Project  
D-NB SMR Designation Request - July 4 2022 (004).pdf

EXTERNAL EMAIL – USE CAUTION / COURRIEL EXTERNE – FAITES PREUVE DE PRUDENCE

UNCLASSIFIED - NON CLASSIFIÉ

Hi Sean,

I hope all is well and you are having a good end to your summer (although it is/has slipped away quickly).

I'm not sure if you had a chance to look at the information submitted by NB Power regarding the proposed SMR demonstration project at Point Lepreau. We are currently reviewing and conducting an analysis to determine (1) if the ARC and Moltex SMRs should be considered one or two separate projects; and (2) if any components are listed on the Physical Activities Regulation, and would therefore already be subject to the requirements of the Impact Assessment Act.

This is part of our preliminary review to determine if the Minister is able to consider designating the project under the IAA, as requested by CRED-NB (see attached).

I was hoping to get the CNSC's input or confirmation on a couple of points. It may be easiest to set up a call early next week to discuss, since there may be details and background that is easier to explain over the phone (or MS Teams), but if there are any you can answer immediately, that would be great. I am relatively free Monday afternoon (Sept 12) or all day Tuesday (Sept 13).

Here are some specific items I was hoping to get CNSC's input/confirmation on:

- What is the status of the Vendor Design Review process for both the ARC and Moltex reactors?
- Confirm that the CNSC is treating the proposed ARC and Moltex SMR commercial demonstration units as separate projects that would be subject to separate licensing, review, and approval.
- Confirm that the Point Lepreau facility is a Class IA nuclear facility, and that the proposed ARC SMR unit and any ancillary facilities would be located within its licensed boundaries.
- Confirm that the proposed ARC SMR project would not involve any activity described in the following sections of the *Physical Activities Regulations*:

**26** The construction, operation and decommissioning of one of the following:

- (a)** a new facility for the processing, reprocessing or separation of isotopes of uranium, thorium, or plutonium, with a production capacity of 100 t/year or more;
- (b)** a new facility for the manufacture of a product derived from uranium, thorium or plutonium, with a production capacity of 100 t/year or more;
- (c)** a new facility for the processing or use, in a quantity greater than  $10^{15}$  Bq per calendar year, of nuclear substances with a half-life greater than one year, other than uranium, thorium or plutonium.

**28** The construction and operation of either of the following:

- (a)** a new facility for the storage of irradiated nuclear fuel or nuclear waste, outside the licensed boundaries of an existing *nuclear facility*, as defined in section 2 of the Nuclear Safety and Control Act, other than a facility for the on-site storage of irradiated nuclear fuel or nuclear waste associated with one or more new fission or fusion reactors that have a combined thermal capacity of less than 200 MWth;
- (b)** a new facility for the long-term management or disposal of irradiated nuclear fuel or nuclear waste.

**29** The expansion of an existing facility for the long-term management or disposal of irradiated nuclear fuel or nuclear waste, if the expansion would result in an increase in the area of the facility, at ground level, of 50% or more

Thanks in advance.

Regards,

Joe

Joe Vigder



(he/him | il)

Project Manager, Atlantic Region

Impact Assessment Agency of Canada / Government of Canada

[joseph.vigder@iaac-aeic.gc.ca](mailto:joseph.vigder@iaac-aeic.gc.ca) / Tel : 902-229-9637

Gestionnaire de projets, région atlantique

Agence d'évaluation d'impact du Canada / Gouvernement du Canada

[joseph.vigder@iaac-aeic.gc.ca](mailto:joseph.vigder@iaac-aeic.gc.ca) / Tél : 902-229-9637

**From:** Gauthier, Rick <[RGauthier@nbpower.com](mailto:RGauthier@nbpower.com)>

**Sent:** September 6, 2022 12:28 PM

**To:** Vigder, Joseph (IAAC/AEIC) <[joseph.vigder@iaac-aeic.gc.ca](mailto:joseph.vigder@iaac-aeic.gc.ca)>; Adams, Jill (IAAC/AEIC) <[Jill.Adams@iaac-aeic.gc.ca](mailto:Jill.Adams@iaac-aeic.gc.ca)>

**Cc:** Harris, Claire <[CHarris@nbpower.com](mailto:CHarris@nbpower.com)>; Hayward, Andy <[AHayward@nbpower.com](mailto:AHayward@nbpower.com)>; McGathey, Andrea <[AMcGathey@nbpower.com](mailto:AMcGathey@nbpower.com)>; Katahwa, Kambale (IAAC/AEIC) <[kambale.katahwa@iaac-aeic.gc.ca](mailto:kambale.katahwa@iaac-aeic.gc.ca)>; Belland, Brenna (IAAC/AEIC) <[Brenna.Belland@iaac-aeic.gc.ca](mailto:Brenna.Belland@iaac-aeic.gc.ca)>; Primeau, Eric (IAAC/AEIC) <[Eric.Primeau@iaac-aeic.gc.ca](mailto:Eric.Primeau@iaac-aeic.gc.ca)>; Belyea, Sean <[Sean.Belyea@cnsccsn.gc.ca](mailto:Sean.Belyea@cnsccsn.gc.ca)>; Plummer, Brett <[BPlummer@nbpower.com](mailto:BPlummer@nbpower.com)>; Woodworth, Wayne <[WWoodworth@nbpower.com](mailto:WWoodworth@nbpower.com)>; Robinson, Rose M <[RRobinson@nbpower.com](mailto:RRobinson@nbpower.com)>

**Subject:** RE: EXT - Notification and Request for Information - Designation Request for SMR Demonstration Project

Hello Joe/Jill, attached is our electronic response letter for the requested information from the Impact Assessment Agency.

Please do not hesitate to contact me with any further inquiries.

Rick Gauthier

*Licensing Manager*

*Advanced Reactor Development Team*

506.651.3286

nbpower.com | energienb.com

**From:** Vigder, Joseph (IAAC/AEIC) <[joseph.vigder@iaac-aeic.gc.ca](mailto:joseph.vigder@iaac-aeic.gc.ca)>

**Sent:** August 10, 2022 1:39 PM

**To:** Gauthier, Rick <[RGauthier@nbpower.com](mailto:RGauthier@nbpower.com)>

**Cc:** Harris, Claire <[CHarris@nbpower.com](mailto:CHarris@nbpower.com)>; Hayward, Andy <[AHayward@nbpower.com](mailto:AHayward@nbpower.com)>; McGathey, Andrea <[AMcGathey@nbpower.com](mailto:AMcGathey@nbpower.com)>; Adams, Jill (IAAC/AEIC) <[Jill.Adams@iaac-aeic.gc.ca](mailto:Jill.Adams@iaac-aeic.gc.ca)>; Katahwa, Kambale (IAAC/AEIC) <[kambale.katahwa@iaac-aeic.gc.ca](mailto:kambale.katahwa@iaac-aeic.gc.ca)>; Belland, Brenna (IAAC/AEIC) <[Brenna.Belland@iaac-aeic.gc.ca](mailto:Brenna.Belland@iaac-aeic.gc.ca)>; Primeau, Eric (IAAC/AEIC) <[Eric.Primeau@iaac-aeic.gc.ca](mailto:Eric.Primeau@iaac-aeic.gc.ca)>; Belyea, Sean <[Sean.Belyea@cnsccsn.gc.ca](mailto:Sean.Belyea@cnsccsn.gc.ca)>

**Subject:** EXT - Notification and Request for Information - Designation Request for SMR Demonstration Project

\*\*\* Attention: External Message / Message externe \*\*\*

UNCLASSIFIED - NON CLASSIFIÉ

Hello Rick,

Please find attached a letter from the Impact Assessment Agency of Canada regarding a request sent to the Minister of Environment and Climate Change to designate a proposed Small Modular Reactor Demonstration Project under the *Impact Assessment Act*.

The original request sent to the Minister is also attached for your information.

Do not hesitate to reach out if you have any questions or would like to discuss the contents of the letter and the information requested.

Thank you,

Joe Vigder

(he/him | il)

Project Manager, Atlantic Region

Impact Assessment Agency of Canada / Government of Canada

[joseph.vigder@iaac-aeic.gc.ca](mailto:joseph.vigder@iaac-aeic.gc.ca) / Tel : 902-229-9637

Gestionnaire de projets, région atlantique

Agence d'évaluation d'impact du Canada / Gouvernement du Canada

[joseph.vigder@iaac-aeic.gc.ca](mailto:joseph.vigder@iaac-aeic.gc.ca) / Tél : 902-229-9637

---

This e-mail communication (including any or all attachments) is intended only for the use of the person or entity to which it is addressed and may contain confidential and/or privileged material. If you are not the intended recipient of this e-mail, any use, review, retransmission, distribution, dissemination, copying, printing, or other use of, or taking of any action in reliance upon this e-mail, is strictly prohibited. If you have received this e-mail in error, please contact the sender and delete the original and any copy of this e-mail and any printout thereof, immediately. Your co-operation is appreciated.

Le présent courriel (y compris toute pièce jointe) s'adresse uniquement à son destinataire, qu'il soit une personne ou un organisme, et pourrait comporter des renseignements privilégiés ou confidentiels. Si vous n'êtes pas le destinataire du courriel, il est interdit d'utiliser, de revoir, de retransmettre, de distribuer, de disséminer, de copier ou d'imprimer ce courriel, d'agir en vous y fiant ou de vous en servir de toute autre façon. Si vous avez reçu le présent courriel par erreur, prière de communiquer avec l'expéditeur et d'éliminer l'original du courriel, ainsi que toute copie électronique ou imprimée de celui-ci, immédiatement. Nous sommes reconnaissants de votre collaboration.

---

## Microsoft Teams meeting

### **Join on your computer, mobile app or room device**

[Click here to join the meeting](#)

Meeting ID: 279 224 490 100

Passcode: GXZHnm

[Download Teams](#) | [Join on the web](#)

### **Or call in (audio only)**

[+1 647-749-9265,,942549588#](#) Canada, Toronto

[\(844\) 632-5179,,942549588#](#) Canada (Toll-free)

Phone Conference ID: 942 549 588#

[Find a local number](#) | [Reset PIN](#)

[Learn More](#) | [Meeting options](#)

---

**Sabo,Ashley (IAAC/AEIC)**

---

**From:** Belyea, Sean <Sean.Belyea@cnscccsn.gc.ca>  
**Sent:** September 12, 2022 8:22 AM  
**To:** Vigder,Joseph (IAAC/AEIC)  
**Subject:** RE: EXT - Notification and Request for Information - Designation Request for SMR Demonstration Project  
  
**Categories:** For ATIP

That's perfectly fine Joe.

Looking forward to the discussion with both Micheline and yourself this afternoon.

Sean

**From:** Vigder,Joseph (IAAC/AEIC) <joseph.vigder@iaac-aeic.gc.ca>  
**Sent:** September 12, 2022 8:17 AM  
**To:** Belyea, Sean <Sean.Belyea@cnscccsn.gc.ca>  
**Subject:** RE: EXT - Notification and Request for Information - Designation Request for SMR Demonstration Project

---

EXTERNAL EMAIL – USE CAUTION / COURRIEL EXTERNE – FAITES PREUVE DE PRUDENCE

---

UNCLASSIFIED - NON CLASSIFIÉ

Good morning Sean.

Just FYI, I am going to invite my colleague Micheline Savard to our call this afternoon. She will likely be working on the actual designation request process assuming we move forward with it for the ARC SMR unit.

Thanks,  
Joe

**From:** Belyea, Sean <Sean.Belyea@cnscccsn.gc.ca>  
**Sent:** September 9, 2022 3:13 PM  
**To:** Vigder,Joseph (IAAC/AEIC) <joseph.vigder@iaac-aeic.gc.ca>  
**Subject:** RE: EXT - Notification and Request for Information - Designation Request for SMR Demonstration Project

Hi Joe,

Things are well here Joe. It's hard to believe it's September. Hope you enjoyed your summer as well.

By all means let's meet early next week to discuss. I sent you an invite for 2:30 on Monday if that works. Feel free to suggest another time.

Thanks for reaching out!

Sean Belyea

Advanced Reactor Licensing Division / Division de l'autorisation des réacteurs avancés

Canadian Nuclear Safety Commission | Commission canadienne de sûreté nucléaire

Ottawa, Canada K1P 5S9

[sean.belyea@cnsccsn.gc.ca](mailto:sean.belyea@cnsccsn.gc.ca) (\*\* Note New Email!)

Telephone | Téléphone [343-573-8179](tel:343-573-8179) (\*\* Note New Number - Voice and SMS (text) Enabled \*\*)

**From:** Vigder, Joseph (IAAC/AEIC) <[joseph.vigder@iaac-aeic.gc.ca](mailto:joseph.vigder@iaac-aeic.gc.ca)>

**Sent:** September 9, 2022 2:03 PM

**To:** Belyea, Sean <[Sean.Belyea@cnsccsn.gc.ca](mailto:Sean.Belyea@cnsccsn.gc.ca)>

**Subject:** RE: EXT - Notification and Request for Information - Designation Request for SMR Demonstration Project

---

EXTERNAL EMAIL – USE CAUTION / COURRIEL EXTERNE – FAITES PREUVE DE PRUDENCE

---

UNCLASSIFIED - NON CLASSIFIÉ

Hi Sean,

I hope all is well and you are having a good end to your summer (although it is/has slipped away quickly).

I'm not sure if you had a chance to look at the information submitted by NB Power regarding the proposed SMR demonstration project at Point Lepreau. We are currently reviewing and conducting an analysis to determine (1) if the ARC and Moltex SMRs should be considered one or two separate projects; and (2) if any components are listed on the *Physical Activities Regulation*, and would therefore already be subject to the requirements of the Impact Assessment Act.

This is part of our preliminary review to determine if the Minister is able to consider designating the project under the IAA, as requested by CRED-NB (see attached).

I was hoping to get the CNSC's input or confirmation on a couple of points. It may be easiest to set up a call early next week to discuss, since there may be details and background that is easier to explain over the phone (or MS Teams), but if there are any you can answer immediately, that would be great. I am relatively free Monday afternoon (Sept 12) or all day Tuesday (Sept 13).

Here are some specific items I was hoping to get CNSC's input/confirmation on:

- What is the status of the Vendor Design Review process for both the ARC and Moltex reactors?
- Confirm that the CNSC is treating the proposed ARC and Moltex SMR commercial demonstration units as separate projects that would be subject to separate licensing, review, and approval.
- Confirm that the Point Lepreau facility is a Class IA nuclear facility, and that the proposed ARC SMR unit and any ancillary facilities would be located within its licensed boundaries.
- Confirm that the proposed ARC SMR project would not involve any activity described in the following sections of the *Physical Activities Regulations*:

**26** The construction, operation and decommissioning of one of the following:

(a) a new facility for the processing, reprocessing or separation of isotopes of uranium, thorium, or plutonium, with a production capacity of 100 t/year or more;

(b) a new facility for the manufacture of a product derived from uranium, thorium or plutonium, with a production capacity of 100 t/year or more;

(c) a new facility for the processing or use, in a quantity greater than  $10^{15}$  Bq per calendar year, of nuclear substances with a half-life greater than one year, other than uranium, thorium or plutonium.

**28** The construction and operation of either of the following:

(a) a new facility for the storage of irradiated nuclear fuel or nuclear waste, outside the licensed boundaries of an existing *nuclear facility*, as defined in section 2 of the Nuclear Safety and Control Act, other than a facility for the on-site storage of irradiated nuclear fuel or nuclear waste associated with one or more new fission or fusion reactors that have a combined thermal capacity of less than 200 MWth;

(b) a new facility for the long-term management or disposal of irradiated nuclear fuel or nuclear waste.

**29** The expansion of an existing facility for the long-term management or disposal of irradiated nuclear fuel or nuclear waste, if the expansion would result in an increase in the area of the facility, at ground level, of 50% or more

Thanks in advance.

Regards,  
Joe

Joe Vigder  
(he/him | il)

Project Manager, Atlantic Region  
Impact Assessment Agency of Canada / Government of Canada  
[joseph.vigder@iaac-aeic.gc.ca](mailto:joseph.vigder@iaac-aeic.gc.ca) / Tel : 902-229-9637

Gestionnaire de projets, région atlantique  
Agence d'évaluation d'impact du Canada / Gouvernement du Canada  
[joseph.vigder@iaac-aeic.gc.ca](mailto:joseph.vigder@iaac-aeic.gc.ca) / Tél : 902-229-9637

**From:** Gauthier, Rick <[RGauthier@nbpower.com](mailto:RGauthier@nbpower.com)>  
**Sent:** September 6, 2022 12:28 PM  
**To:** Vigder, Joseph (IAAC/AEIC) <[joseph.vigder@iaac-aeic.gc.ca](mailto:joseph.vigder@iaac-aeic.gc.ca)>; Adams, Jill (IAAC/AEIC) <[Jill.Adams@iaac-aeic.gc.ca](mailto:Jill.Adams@iaac-aeic.gc.ca)>  
**Cc:** Harris, Claire <[CHarris@nbpower.com](mailto:CHarris@nbpower.com)>; Hayward, Andy <[AHayward@nbpower.com](mailto:AHayward@nbpower.com)>; McGathey, Andrea <[AMcGathey@nbpower.com](mailto:AMcGathey@nbpower.com)>; Katahwa, Kambale (IAAC/AEIC) <[kambale.katahwa@iaac-aeic.gc.ca](mailto:kambale.katahwa@iaac-aeic.gc.ca)>; Belland, Brenna (IAAC/AEIC) <[Brenna.Belland@iaac-aeic.gc.ca](mailto:Brenna.Belland@iaac-aeic.gc.ca)>; Primeau, Eric (IAAC/AEIC) <[Eric.Primeau@iaac-aeic.gc.ca](mailto:Eric.Primeau@iaac-aeic.gc.ca)>; Belyea, Sean <[Sean.Belyea@cnsccsn.gc.ca](mailto:Sean.Belyea@cnsccsn.gc.ca)>; Plummer, Brett <[BPlummer@nbpower.com](mailto:BPlummer@nbpower.com)>; Woodworth, Wayne <[WWoodworth@nbpower.com](mailto:WWoodworth@nbpower.com)>; Robinson, Rose M <[RRobinson@nbpower.com](mailto:RRobinson@nbpower.com)>  
**Subject:** RE: EXT - Notification and Request for Information - Designation Request for SMR Demonstration Project

Hello Joe/Jill, attached is our electronic response letter for the requested information from the Impact Assessment Agency.

Please do not hesitate to contact me with any further inquiries.



Rick Gauthier  
*Licensing Manager*  
*Advanced Reactor Development Team*  
506.651.3286  
[nbpower.com](mailto:nbpower.com) | [energienb.com](http://energienb.com)

**From:** Vigder, Joseph (IAAC/AEIC) <[joseph.vigder@iaac-aeic.gc.ca](mailto:joseph.vigder@iaac-aeic.gc.ca)>  
**Sent:** August 10, 2022 1:39 PM  
**To:** Gauthier, Rick <[RGauthier@nbpower.com](mailto:RGauthier@nbpower.com)>  
**Cc:** Harris, Claire <[CHarris@nbpower.com](mailto:CHarris@nbpower.com)>; Hayward, Andy <[AHayward@nbpower.com](mailto:AHayward@nbpower.com)>; McGathey, Andrea <[AMcGathey@nbpower.com](mailto:AMcGathey@nbpower.com)>; Adams, Jill (IAAC/AEIC) <[Jill.Adams@iaac-aeic.gc.ca](mailto:Jill.Adams@iaac-aeic.gc.ca)>; Katahwa, Kambale (IAAC/AEIC) <[kambale.katahwa@iaac-aeic.gc.ca](mailto:kambale.katahwa@iaac-aeic.gc.ca)>; Belland, Brenna (IAAC/AEIC) <[Brenna.Belland@iaac-aeic.gc.ca](mailto:Brenna.Belland@iaac-aeic.gc.ca)>; Primeau, Eric (IAAC/AEIC) <[Eric.Primeau@iaac-aeic.gc.ca](mailto:Eric.Primeau@iaac-aeic.gc.ca)>; Belyea, Sean <[Sean.Belyea@cnsccsn.gc.ca](mailto:Sean.Belyea@cnsccsn.gc.ca)>  
**Subject:** EXT - Notification and Request for Information - Designation Request for SMR Demonstration Project

\*\*\* Attention: External Message / Message externe \*\*\*

UNCLASSIFIED - NON CLASSIFIÉ

Hello Rick,



Please find attached a letter from the Impact Assessment Agency of Canada regarding a request sent to the Minister of Environment and Climate Change to designate a proposed Small Modular Reactor Demonstration Project under the *Impact Assessment Act*.

The original request sent to the Minister is also attached for your information.

Do not hesitate to reach out if you have any questions or would like to discuss the contents of the letter and the information requested.

Thank you,

Joe Vigder  
(he/him | il)

Project Manager, Atlantic Region  
Impact Assessment Agency of Canada / Government of Canada  
[joseph.vigder@iaac-aeic.gc.ca](mailto:joseph.vigder@iaac-aeic.gc.ca) / Tel : 902-229-9637

Gestionnaire de projets, région atlantique  
Agence d'évaluation d'impact du Canada / Gouvernement du Canada  
[joseph.vigder@iaac-aeic.gc.ca](mailto:joseph.vigder@iaac-aeic.gc.ca) / Tél : 902-229-9637



---

This e-mail communication (including any or all attachments) is intended only for the use of the person or entity to which it is addressed and may contain confidential and/or privileged material. If you are not the intended recipient of this e-mail, any use, review, retransmission, distribution, dissemination, copying, printing, or other use of, or taking of any action in reliance upon this e-mail, is strictly prohibited. If you have received this e-mail in error, please contact the sender and delete the original and any copy of this e-mail and any printout thereof, immediately. Your co-operation is appreciated.

Le présent courriel (y compris toute pièce jointe) s'adresse uniquement à son destinataire, qu'il soit une personne ou un organisme, et pourrait comporter des renseignements privilégiés ou confidentiels. Si vous n'êtes pas le destinataire du courriel, il est interdit d'utiliser, de revoir, de retransmettre, de distribuer, de disséminer, de copier ou d'imprimer ce courriel, d'agir en vous y fiant ou de vous en servir de toute autre façon. Si vous avez reçu le présent courriel par erreur, prière de communiquer avec l'expéditeur et d'éliminer l'original du courriel, ainsi que toute copie électronique ou imprimée de celui-ci, immédiatement. Nous sommes reconnaissants de votre collaboration.

## Sabo,Ashley (IAAC/AEIC)

---

**From:** Belyea, Sean <Sean.Belyea@cnsccsn.gc.ca>  
**Sent:** September 13, 2022 3:45 PM  
**To:** Vigder,Joseph (IAAC/AEIC)  
**Cc:** Savard,Micheline (IAAC/AEIC); Harpell, Heather  
**Subject:** RE: NB Power SMR Demonstration Project - CNSC Input

**Categories:** For ATIP

Hi Joe,

Everything you mentioned below is factual. I did want to elaborate on the following statement:

- The CNSC is of the view that the proposed ARC SMR and the Moltex SMR commercial demonstration units are two separate and independent projects. The CNSC will review the licence applications and approve each project independently.

As you know, NB Power is in charge of their plan. They have indicated to the CNSC that they are pursuing possible plans for a licence to prepare site application to the CNSC for a single ARC unit at the Point Lepreau site, with the possibility of a MOLTEX facility in the future. Those plans as indicated by NB Power are anticipated to be 2 separate licenses. Should they build both facilities, the CNSC licensing process would ask that any possible interactions between new or existing reactors on sight be considered. NB Power could change their plans at any time, and the CNSC would adjust any licensing activities appropriately.

All the above to say that the CNSC doesn't have a 'view' of the proposed activities. It would be factual to state that NB Power has indicated to the CNSC that the proposed ARC SMR and the Moltex SMR commercial demonstration units would be two separate and independent projects. NB Power's plans are fluid, and subject to change at their discretion.

I hope that helps – and as mentioned, feel free to reach out at any time.

I also copied Heather for her information from an EA perspective.

Sean

**From:** Vigder,Joseph (IAAC/AEIC) <joseph.vigder@iaac-aeic.gc.ca>  
**Sent:** September 13, 2022 9:35 AM  
**To:** Belyea, Sean <Sean.Belyea@cnsccsn.gc.ca>

Cc: Savard, Micheline (IAAC/AEIC) <micheline.savard@iaac-aeic.gc.ca>

Subject: NB Power SMR Demonstration Project - CNSC Input

EXTERNAL EMAIL – USE CAUTION / COURRIEL EXTERNE – FAITES PREUVE DE PRUDENCE

UNCLASSIFIED - NON CLASSIFIÉ

Hi Sean,

Thanks for the chat yesterday. I found it very helpful.

As mentioned, I wanted to run a few things by you to ensure we are accurately reflecting CNSC's perspective regarding NB Power's currently proposed activities. If you could, please review the points we discussed below and confirm or add any additional points of correction or clarification, as necessary.

- The CNSC is of the view that the proposed ARC SMR and the Moltex SMR commercial demonstration units are two separate and independent projects. The CNSC will review the licence applications and approve each project independently.
- Based on the information currently available, the proposed ARC SMR demonstration unit would be fully located within the boundaries of the Class IA Point Lepreau Nuclear Facility.
- Based on the information currently available, the proposed ARC SMR demonstration unit would not involve any of the following activities described in the *Physical Activities Regulations*:
  - 26** The construction, operation and decommissioning of...:
    - (c) a new facility for the processing or use, in a quantity greater than  $10^{15}$  Bq per calendar year, of nuclear substances with a half-life greater than one year, other than uranium, thorium or plutonium.
  - 28** The construction and operation of...:
    - (b) a new facility for the long-term management or disposal of irradiated nuclear fuel or nuclear waste.
  - 29** The expansion of an existing facility for the long-term management or disposal of irradiated nuclear fuel or nuclear waste, if the expansion would result in an increase in the area of the facility, at ground level, of 50% or more.

Thanks again, and don't hesitate to reach out if you have any questions or wish to discuss anything.

Regards,  
Joe

Joe Vigder  
(he/him | il)

Project Manager, Atlantic Region  
Impact Assessment Agency of Canada / Government of Canada  
[joseph.vigder@iaac-aeic.gc.ca](mailto:joseph.vigder@iaac-aeic.gc.ca) / Tel : 902-229-9637

Gestionnaire de projets, région atlantique  
Agence d'évaluation d'impact du Canada / Gouvernement du Canada  
[joseph.vigder@iaac-aeic.gc.ca](mailto:joseph.vigder@iaac-aeic.gc.ca) / Tél : 902-229-9637



Canada

**From:** Gauthier, Rick <[RGauthier@nbpower.com](mailto:RGauthier@nbpower.com)>

**Sent:** September 6, 2022 12:28 PM

**To:** Vigder, Joseph (IAAC/AEIC) <[joseph.vigder@iaac-aeic.gc.ca](mailto:joseph.vigder@iaac-aeic.gc.ca)>; Adams, Jill (IAAC/AEIC) <[Jill.Adams@iaac-aeic.gc.ca](mailto:Jill.Adams@iaac-aeic.gc.ca)>

**Cc:** Harris, Claire <[CHarris@nbpower.com](mailto:CHarris@nbpower.com)>; Hayward, Andy <[AHayward@nbpower.com](mailto:AHayward@nbpower.com)>; McGathey, Andrea <[AMcGathey@nbpower.com](mailto:AMcGathey@nbpower.com)>; Katahwa, Kambale (IAAC/AEIC) <[kambale.katahwa@iaac-aeic.gc.ca](mailto:kambale.katahwa@iaac-aeic.gc.ca)>; Belland, Brenna (IAAC/AEIC) <[Brenna.Belland@iaac-aeic.gc.ca](mailto:Brenna.Belland@iaac-aeic.gc.ca)>; Primeau, Eric (IAAC/AEIC) <[Eric.Primeau@iaac-aeic.gc.ca](mailto:Eric.Primeau@iaac-aeic.gc.ca)>; Belyea, Sean <[Sean.Belyea@cnsccsn.gc.ca](mailto:Sean.Belyea@cnsccsn.gc.ca)>; Plummer, Brett <[BPlummer@nbpower.com](mailto:BPlummer@nbpower.com)>; Woodworth, Wayne <[WWoodworth@nbpower.com](mailto:WWoodworth@nbpower.com)>; Robinson, Rose M <[RRobinson@nbpower.com](mailto:RRobinson@nbpower.com)>

**Subject:** RE: EXT - Notification and Request for Information - Designation Request for SMR Demonstration Project

Hello Joe/Jill, attached is our electronic response letter for the requested information from the Impact Assessment Agency.

Please do not hesitate to contact me with any further inquiries.

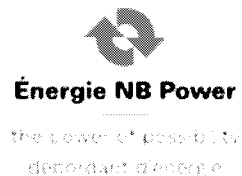

Rick Gauthier  
*Licensing Manager*  
*Advanced Reactor Development Team*  
506.651.3286  
[nbpower.com](mailto:nbpower.com) | [energienb.com](http://energienb.com)

**From:** Vigder, Joseph (IAAC/AEIC) <[joseph.vigder@iaac-aeic.gc.ca](mailto:joseph.vigder@iaac-aeic.gc.ca)>

**Sent:** August 10, 2022 1:39 PM

**To:** Gauthier, Rick <[RGauthier@nbpower.com](mailto:RGauthier@nbpower.com)>

**Cc:** Harris, Claire <[CHarris@nbpower.com](mailto:CHarris@nbpower.com)>; Hayward, Andy <[AHayward@nbpower.com](mailto:AHayward@nbpower.com)>; McGathey, Andrea <[AMcGathey@nbpower.com](mailto:AMcGathey@nbpower.com)>; Adams, Jill (IAAC/AEIC) <[Jill.Adams@iaac-aeic.gc.ca](mailto:Jill.Adams@iaac-aeic.gc.ca)>; Katahwa, Kambale (IAAC/AEIC) <[kambale.katahwa@iaac-aeic.gc.ca](mailto:kambale.katahwa@iaac-aeic.gc.ca)>; Belland, Brenna (IAAC/AEIC) <[Brenna.Belland@iaac-aeic.gc.ca](mailto:Brenna.Belland@iaac-aeic.gc.ca)>; Primeau, Eric (IAAC/AEIC) <[Eric.Primeau@iaac-aeic.gc.ca](mailto:Eric.Primeau@iaac-aeic.gc.ca)>; Belyea, Sean <[Sean.Belyea@cnsccsn.gc.ca](mailto:Sean.Belyea@cnsccsn.gc.ca)>

**Subject:** EXT - Notification and Request for Information - Designation Request for SMR Demonstration Project

\*\*\* Attention: External Message / Message externe \*\*\*

Hello Rick,

Please find attached a letter from the Impact Assessment Agency of Canada regarding a request sent to the Minister of Environment and Climate Change to designate a proposed Small Modular Reactor Demonstration Project under the *Impact Assessment Act*.

The original request sent to the Minister is also attached for your information.

Do not hesitate to reach out if you have any questions or would like to discuss the contents of the letter and the information requested.

Thank you,

Joe Vigder  
(he/him | il)

Project Manager, Atlantic Region  
Impact Assessment Agency of Canada / Government of Canada  
[joseph.vigder@iaac-aeic.gc.ca](mailto:joseph.vigder@iaac-aeic.gc.ca) / Tel : 902-229-9637

Gestionnaire de projets, région atlantique  
Agence d'évaluation d'impact du Canada / Gouvernement du Canada  
[joseph.vigder@iaac-aeic.gc.ca](mailto:joseph.vigder@iaac-aeic.gc.ca) / Tél : 902-229-9637



Canada

---

This e-mail communication (including any or all attachments) is intended only for the use of the person or entity to which it is addressed and may contain confidential and/or privileged material. If you are not the intended recipient of this e-mail, any use, review, retransmission, distribution, dissemination, copying, printing, or other use of, or taking of any action in reliance upon this e-mail, is strictly prohibited. If you have received this e-mail in error, please contact the sender and delete the original and any copy of this e-mail and any printout thereof, immediately. Your co-operation is appreciated.

Le présent courriel (y compris toute pièce jointe) s'adresse uniquement à son destinataire, qu'il soit une personne ou un organisme, et pourrait comporter des renseignements privilégiés ou confidentiels. Si vous n'êtes pas le destinataire du courriel, il est interdit d'utiliser, de revoir, de retransmettre, de distribuer, de disséminer, de copier ou d'imprimer ce courriel, d'agir en vous y fiant ou de vous en servir de toute autre façon. Si vous avez reçu le présent courriel par erreur, prière de communiquer avec l'expéditeur et d'éliminer l'original du courriel, ainsi que toute copie électronique ou imprimée de celui-ci, immédiatement. Nous sommes reconnaissants de votre collaboration.

## Sabo,Ashley (IAAC/AEIC)

---

**From:** Thompson, Paul <PThompson@nbpower.com>  
**Sent:** September 15, 2022 9:26 AM  
**To:** Vigder,Joseph (IAAC/AEIC)  
**Cc:** Gauthier, Rick; McGathey, Andrea; Harris, Claire  
**Subject:** RE: EXT - Notification and Request for Information - Designation Request for SMR Demonstration Project  
**Attachments:** IAAC Designation Request Review Meeting July 28\_2022.pdf

**Categories:** For ATIP

Hi Joe, thanks for pointing this out. Moltex is at an early stage in the R&D and design so the in-service date has a high degree of uncertainty and hence the note on the slide that *the level 1 schedule is under construction*. However for now it might be best to assume a commercial operation date of around mid 2030's, not late 2030's, until we are able to achieve further clarity. All of this is contingent on Moltex demonstrating technical and economic feasibility of both WATSS fuel reprocessing and the SSR-W reactor and their associated integration.  
Hope this helps...  
Paul

**From:** Vigder,Joseph (IAAC/AEIC) <joseph.vigder@iaac-aeic.gc.ca>  
**Sent:** September 15, 2022 9:40 AM  
**To:** Thompson, Paul <PThompson@nbpower.com>  
**Cc:** Gauthier, Rick <RGauthier@nbpower.com>; McGathey, Andrea <AMcGathey@nbpower.com>; Harris, Claire <CHarris@nbpower.com>  
**Subject:** RE: EXT - Notification and Request for Information - Designation Request for SMR Demonstration Project

Hi Paul,

I had another quick point of clarification I wanted to run by you. In the attached presentation, slide 10 indicates that commercial operation of the Moltex SMR unit is not anticipated until late ~2030's. I just wanted to confirm this timeline estimate with you, and confirm that this would be for a single Moltex commercial demonstration unit.

Thanks,  
Joe

**From:** Thompson, Paul <PThompson@nbpower.com>  
**Sent:** September 14, 2022 1:40 PM  
**To:** Vigder,Joseph (IAAC/AEIC) <joseph.vigder@iaac-aeic.gc.ca>

**Cc:** Gauthier, Rick <[RGauthier@nbpower.com](mailto:RGauthier@nbpower.com)>; McGathey, Andrea <[AMcGathey@nbpower.com](mailto:AMcGathey@nbpower.com)>; Harris, Claire <[CHarris@nbpower.com](mailto:CHarris@nbpower.com)>  
**Subject:** RE: EXT - Notification and Request for Information - Designation Request for SMR Demonstration Project

Hi Joe, yes the used fuel for the ARC-100 is initially stored in the periphery of the core to allow for radioactive decay to reduce the heat load and thus cooling requirements. I believe the used fuel needs to reside there for at least 6 months, but I am not sure of the exact time off the top of my head. At an appropriate opportunity after the minimum decay time (a convenient maintenance outage for example) the fuel will be withdrawn and loaded into dry casks, where it will be stored on-site until after final shutdown where, as part of decommissioning, it will be transported to the Deep Geological Repository for long term disposal. It should be noted that the fuel string is much longer than a CANDU bundle, so the interim storage will be different than that used currently for the Lepreau used CANDU fuel. The overall description of the ARC-100 facility will include an allowance to store 3 core loads of used fuel on site for interim storage before it is shipped to the DGR at the end of station life.

Hope this helps address your question.

Paul

**From:** Gauthier, Rick <[RGauthier@nbpower.com](mailto:RGauthier@nbpower.com)>

**Sent:** September 14, 2022 12:42 PM

**To:** Vigder, Joseph (IAAC/AEIC) <[joseph.vigder@iaac-aeic.gc.ca](mailto:joseph.vigder@iaac-aeic.gc.ca)>

**Cc:** Thompson, Paul <[PTHompson@nbpower.com](mailto:PTHompson@nbpower.com)>

**Subject:** RE: EXT - Notification and Request for Information - Designation Request for SMR Demonstration Project

Joe

Thompson will reply.

Thanks, Rick

I have your question and a response is being gathered by a team member. Paul

Sent with BlackBerry Work

([www.blackberry.com](http://www.blackberry.com))

---

**From:** Vigder, Joseph (IAAC/AEIC) <[joseph.vigder@iaac-aeic.gc.ca](mailto:joseph.vigder@iaac-aeic.gc.ca)>

**Date:** Wednesday, Sep 14, 2022, 11:49

**To:** Gauthier, Rick <[RGauthier@nbpower.com](mailto:RGauthier@nbpower.com)>

**Subject:** RE: EXT - Notification and Request for Information - Designation Request for SMR Demonstration Project

UNCLASSIFIED - NON CLASSIFIÉ

Hi Rick,

I have a quick question for you as we continue to review the information you provided last week:

Page 2 of the document states that, for the ARC SMR, "...after the 20 years the fuel will be stored internally in the periphery of the reactor vessel." My understanding is that the spent fuel would be stored here temporarily to "cool off" before it is moved to the existing dry-cask storage at the Point Lepreau Facility. Can you confirm that is indeed the case, and approximately how long the spent fuel is stored before moving it to the dry cask storage?

Hope the question is clear, and happy to chat if it is easier to explain some things face-to-face.

Thanks,  
Joe

**From:** Gauthier, Rick <[RGauthier@nbpower.com](mailto:RGauthier@nbpower.com)>  
**Sent:** September 6, 2022 12:28 PM  
**To:** Vigder, Joseph (IAAC/AEIC) <[joseph.vigder@iaac-aeic.gc.ca](mailto:joseph.vigder@iaac-aeic.gc.ca)>; Adams, Jill (IAAC/AEIC) <[Jill.Adams@iaac-aeic.gc.ca](mailto:Jill.Adams@iaac-aeic.gc.ca)>  
**Cc:** Harris, Claire <[CHarris@nbpower.com](mailto:CHarris@nbpower.com)>; Hayward, Andy <[AHayward@nbpower.com](mailto:AHayward@nbpower.com)>; McGathey, Andrea <[AMcGathey@nbpower.com](mailto:AMcGathey@nbpower.com)>; Katahwa, Kambale (IAAC/AEIC) <[kambale.katahwa@iaac-aeic.gc.ca](mailto:kambale.katahwa@iaac-aeic.gc.ca)>; Belland, Brenna (IAAC/AEIC) <[Brenna.Belland@iaac-aeic.gc.ca](mailto:Brenna.Belland@iaac-aeic.gc.ca)>; Primeau, Eric (IAAC/AEIC) <[Eric.Primeau@iaac-aeic.gc.ca](mailto:Eric.Primeau@iaac-aeic.gc.ca)>; Belyea, Sean <[Sean.Belyea@cnsccsn.gc.ca](mailto:Sean.Belyea@cnsccsn.gc.ca)>; Plummer, Brett <[BPlummer@nbpower.com](mailto:BPlummer@nbpower.com)>; Woodworth, Wayne <[WWoodworth@nbpower.com](mailto:WWoodworth@nbpower.com)>; Robinson, Rose M <[RRobinson@nbpower.com](mailto:RRobinson@nbpower.com)>  
**Subject:** RE: EXT - Notification and Request for Information - Designation Request for SMR Demonstration Project

Hello Joe/Jill, attached is our electronic response letter for the requested information from the Impact Assessment Agency.

Please do not hesitate to contact me with any further inquiries.

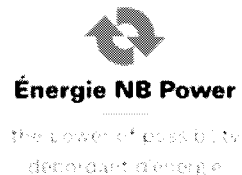

Rick Gauthier  
*Licensing Manager*  
*Advanced Reactor Development Team*  
506.651.3286  
[nbpower.com](http://nbpower.com) | [energienb.com](http://energienb.com)

**From:** Vigder, Joseph (IAAC/AEIC) <[joseph.vigder@iaac-aeic.gc.ca](mailto:joseph.vigder@iaac-aeic.gc.ca)>  
**Sent:** August 10, 2022 1:39 PM  
**To:** Gauthier, Rick <[RGauthier@nbpower.com](mailto:RGauthier@nbpower.com)>  
**Cc:** Harris, Claire <[CHarris@nbpower.com](mailto:CHarris@nbpower.com)>; Hayward, Andy <[AHayward@nbpower.com](mailto:AHayward@nbpower.com)>; McGathey, Andrea <[AMcGathey@nbpower.com](mailto:AMcGathey@nbpower.com)>; Adams, Jill (IAAC/AEIC) <[Jill.Adams@iaac-aeic.gc.ca](mailto:Jill.Adams@iaac-aeic.gc.ca)>; Katahwa, Kambale (IAAC/AEIC) <[kambale.katahwa@iaac-aeic.gc.ca](mailto:kambale.katahwa@iaac-aeic.gc.ca)>; Belland, Brenna (IAAC/AEIC) <[Brenna.Belland@iaac-aeic.gc.ca](mailto:Brenna.Belland@iaac-aeic.gc.ca)>; Primeau, Eric (IAAC/AEIC) <[Eric.Primeau@iaac-aeic.gc.ca](mailto:Eric.Primeau@iaac-aeic.gc.ca)>; Belyea, Sean <[Sean.Belyea@cnsccsn.gc.ca](mailto:Sean.Belyea@cnsccsn.gc.ca)>  
**Subject:** EXT - Notification and Request for Information - Designation Request for SMR Demonstration Project



\*\*\* Attention: External Message / Message externe \*\*\*

UNCLASSIFIED - NON CLASSIFIÉ

Hello Rick,

Please find attached a letter from the Impact Assessment Agency of Canada regarding a request sent to the Minister of Environment and Climate Change to designate a proposed Small Modular Reactor Demonstration Project under the *Impact Assessment Act*.

The original request sent to the Minister is also attached for your information.

Do not hesitate to reach out if you have any questions or would like to discuss the contents of the letter and the information requested.

Thank you,

Joe Vigder  
(he/him | il)

Project Manager, Atlantic Region  
Impact Assessment Agency of Canada / Government of Canada  
[joseph.vigder@iaac-aeic.gc.ca](mailto:joseph.vigder@iaac-aeic.gc.ca) / Tel : 902-229-9637

Gestionnaire de projets, région atlantique  
Agence d'évaluation d'impact du Canada / Gouvernement du Canada  
[joseph.vigder@iaac-aeic.gc.ca](mailto:joseph.vigder@iaac-aeic.gc.ca) / Tél : 902-229-9637



Canada

---

This e-mail communication (including any or all attachments) is intended only for the use of the person or entity to which it is addressed and may contain confidential and/or privileged material. If you are not the intended recipient of this e-mail, any use, review, retransmission, distribution, dissemination, copying, printing, or other use of, or taking of any action in reliance upon this e-mail, is strictly prohibited. If you have received this e-mail in error, please contact the sender and delete the original and any copy of this e-mail and any printout thereof, immediately. Your co-operation is appreciated.

Le présent courriel (y compris toute pièce jointe) s'adresse uniquement à son destinataire, qu'il soit une personne ou un organisme, et pourrait comporter des renseignements privilégiés ou confidentiels. Si vous n'êtes pas le destinataire du courriel, il est interdit d'utiliser, de revoir, de retransmettre, de distribuer, de disséminer, de copier ou d'imprimer ce courriel, d'agir en vous y fiant ou de vous en servir de toute autre façon. Si vous avez reçu le présent courriel par erreur, prière de communiquer avec l'expéditeur et d'éliminer l'original du courriel, ainsi que toute copie électronique ou imprimée de celui-ci, immédiatement. Nous sommes reconnaissants de votre collaboration.

**Sabo,Ashley (IAAC/AEIC)**

---

**From:** Gauthier, Rick <RGauthier@nbpower.com>  
**Sent:** September 22, 2022 12:01 PM  
**To:** Vigder,Joseph (IAAC/AEIC)  
**Cc:** Harris, Claire; McGathey, Andrea; Adams,Jill (IAAC/AEIC); Savard,Micheline (IAAC/AEIC); Hayward, Andy; Thompson, Paul; Woodworth, Wayne; Robinson, Rose M; Higgins, Will; Smith, Brent; Plummer, Brett  
**Subject:** RE: EXT - Notification and Request for Information - Designation Request for SMR Demonstration Project

Joe, we understand that you may be potentially initiating the designation request. NBP has no issues with you sharing the information we provided to answer your formal request or the slides we discussed at our meeting.

Thanks,  
Rick Gauthier

**From:** Vigder,Joseph (IAAC/AEIC) <joseph.vigder@iaac-aeic.gc.ca>  
**Sent:** September 22, 2022 12:40 PM  
**To:** Gauthier, Rick <RGauthier@nbpower.com>  
**Cc:** Harris, Claire <CHarris@nbpower.com>; McGathey, Andrea <AMcGathey@nbpower.com>; Adams,Jill (IAAC/AEIC) <Jill.Adams@iaac-aeic.gc.ca>; Savard,Micheline (IAAC/AEIC) <micheline.savard@iaac-aeic.gc.ca>  
**Subject:** RE: EXT - Notification and Request for Information - Designation Request for SMR Demonstration Project

UNCLASSIFIED - NON CLASSIFIÉ

Hello Rick,

It is probably a good thing it wasn't this weekend, as it looks like we may be in for some nasty weather.

Regarding the request from CRED-NB for the Minister to designate the SMR demonstration project, we will potentially be initiating a designation request process shortly. As part of the process, we would reach out to Federal Authorities and potentially impacted Indigenous groups to seek input and opinions to help inform the Minister's decision. To help inform their input, we may share information on the proposed project. I wanted to give you a heads-up that this may include sharing the information NB Power submitted in response to our request for information. If you have any issues with this, please let me know.

Thanks,

Joe

**From:** Gauthier, Rick <[RGauthier@nbpower.com](mailto:RGauthier@nbpower.com)>

**Sent:** September 6, 2022 12:28 PM

**To:** Vigder, Joseph (IAAC/AEIC) <[joseph.vigder@iaac-aeic.gc.ca](mailto:joseph.vigder@iaac-aeic.gc.ca)>; Adams, Jill (IAAC/AEIC) <[Jill.Adams@iaac-aeic.gc.ca](mailto:Jill.Adams@iaac-aeic.gc.ca)>

**Cc:** Harris, Claire <[CHarris@nbpower.com](mailto:CHarris@nbpower.com)>; Hayward, Andy <[AHayward@nbpower.com](mailto:AHayward@nbpower.com)>; McGathey, Andrea <[AMcGathey@nbpower.com](mailto:AMcGathey@nbpower.com)>; Katahwa, Kambale (IAAC/AEIC) <[kambale.katahwa@iaac-aeic.gc.ca](mailto:kambale.katahwa@iaac-aeic.gc.ca)>; Belland, Brenna (IAAC/AEIC) <[Brenna.Belland@iaac-aeic.gc.ca](mailto:Brenna.Belland@iaac-aeic.gc.ca)>; Primeau, Eric (IAAC/AEIC) <[Eric.Primeau@iaac-aeic.gc.ca](mailto:Eric.Primeau@iaac-aeic.gc.ca)>; Belyea, Sean <[Sean.Belyea@cnscccsn.gc.ca](mailto:Sean.Belyea@cnscccsn.gc.ca)>; Plummer, Brett <[BPlummer@nbpower.com](mailto:BPlummer@nbpower.com)>; Woodworth, Wayne <[WWoodworth@nbpower.com](mailto:WWoodworth@nbpower.com)>; Robinson, Rose M <[RRobinson@nbpower.com](mailto:RRobinson@nbpower.com)>

**Subject:** RE: EXT - Notification and Request for Information - Designation Request for SMR Demonstration Project

Hello Joe/Jill, attached is our electronic response letter for the requested information from the Impact Assessment Agency.

Please do not hesitate to contact me with any further inquiries.



Rick Gauthier  
*Licensing Manager*  
*Advanced Reactor Development Team*  
506.651.3286  
nbpower.com | energienb.com

**From:** Vigder, Joseph (IAAC/AEIC) <[joseph.vigder@iaac-aeic.gc.ca](mailto:joseph.vigder@iaac-aeic.gc.ca)>

**Sent:** August 10, 2022 1:39 PM

**To:** Gauthier, Rick <[RGauthier@nbpower.com](mailto:RGauthier@nbpower.com)>

**Cc:** Harris, Claire <[CHarris@nbpower.com](mailto:CHarris@nbpower.com)>; Hayward, Andy <[AHayward@nbpower.com](mailto:AHayward@nbpower.com)>; McGathey, Andrea <[AMcGathey@nbpower.com](mailto:AMcGathey@nbpower.com)>; Adams, Jill (IAAC/AEIC) <[Jill.Adams@iaac-aeic.gc.ca](mailto:Jill.Adams@iaac-aeic.gc.ca)>; Katahwa, Kambale (IAAC/AEIC) <[kambale.katahwa@iaac-aeic.gc.ca](mailto:kambale.katahwa@iaac-aeic.gc.ca)>; Belland, Brenna (IAAC/AEIC) <[Brenna.Belland@iaac-aeic.gc.ca](mailto:Brenna.Belland@iaac-aeic.gc.ca)>; Primeau, Eric (IAAC/AEIC) <[Eric.Primeau@iaac-aeic.gc.ca](mailto:Eric.Primeau@iaac-aeic.gc.ca)>; Belyea, Sean <[Sean.Belyea@cnscccsn.gc.ca](mailto:Sean.Belyea@cnscccsn.gc.ca)>

**Subject:** EXT - Notification and Request for Information - Designation Request for SMR Demonstration Project

\*\*\* Attention: External Message / Message externe \*\*\*

UNCLASSIFIED - NON CLASSIFIÉ

Hello Rick,

Please find attached a letter from the Impact Assessment Agency of Canada regarding a request sent to the Minister of Environment and Climate Change to designate a proposed Small Modular Reactor Demonstration Project under the *Impact Assessment Act*.

The original request sent to the Minister is also attached for your information.

Do not hesitate to reach out if you have any questions or would like to discuss the contents of the letter and the information requested.

Thank you,

Joe Vigder  
(he/him | il)

Project Manager, Atlantic Region  
Impact Assessment Agency of Canada / Government of Canada  
[joseph.vigder@iaac-aeic.gc.ca](mailto:joseph.vigder@iaac-aeic.gc.ca) / Tel : 902-229-9637

Gestionnaire de projets, région atlantique  
Agence d'évaluation d'impact du Canada / Gouvernement du Canada  
[joseph.vigder@iaac-aeic.gc.ca](mailto:joseph.vigder@iaac-aeic.gc.ca) / Tél : 902-229-9637



Canada

---

This e-mail communication (including any or all attachments) is intended only for the use of the person or entity to which it is addressed and may contain confidential and/or privileged material. If you are not the intended recipient of this e-mail, any use, review, retransmission, distribution, dissemination, copying, printing, or other use of, or taking of any action in reliance upon this e-mail, is strictly prohibited. If you have received this e-mail in error, please contact the sender and delete the original and any copy of this e-mail and any printout thereof, immediately. Your co-operation is appreciated.

Le présent courriel (y compris toute pièce jointe) s'adresse uniquement à son destinataire, qu'il soit une personne ou un organisme, et pourrait comporter des renseignements privilégiés ou confidentiels. Si vous n'êtes pas le destinataire du courriel, il est interdit d'utiliser, de revoir, de retransmettre, de distribuer, de disséminer, de copier ou d'imprimer ce courriel, d'agir en vous y fiant ou de vous en servir de toute autre façon. Si vous avez reçu le présent courriel par erreur, prière de communiquer avec l'expéditeur et d'éliminer l'original du courriel, ainsi que toute copie électronique ou imprimée de celui-ci, immédiatement. Nous sommes reconnaissants de votre collaboration.

**Sabo,Ashley (IAAC/AEIC)**

---

**From:** Gauthier, Rick <RGauthier@nbpower.com>  
**Sent:** September 28, 2022 9:43 AM  
**To:** Vigder,Joseph (IAAC/AEIC)  
**Cc:** Harris, Claire; Hayward, Andy  
**Subject:** Moltex Facility at Point Lepreau NB

**Categories:** For ATIP

Good day Joe, as requested, a picture of the potential future site for the Moltex facility.

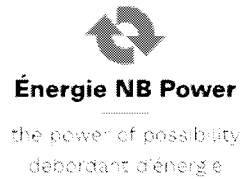

Rick Gauthier  
*Licensing Manager*  
*Advanced Reactor Development Team*  
506.651.3286  
nbpower.com | energienb.com

## Potential Location for Moltex

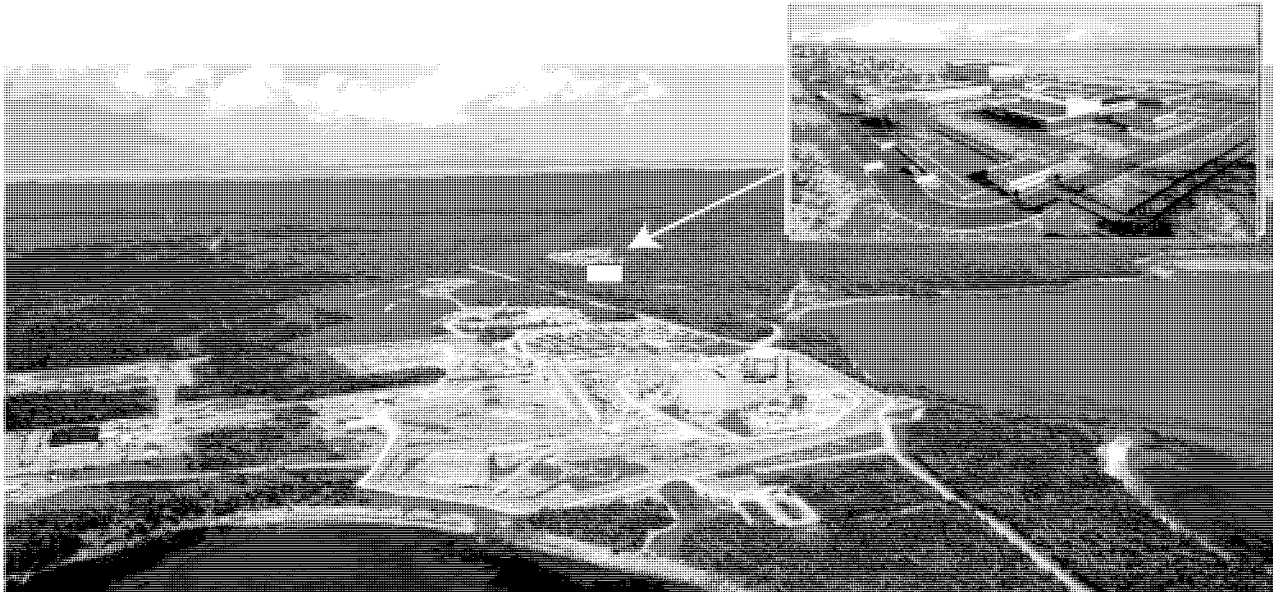

---

This e-mail communication (including any or all attachments) is intended only for the use of the person or entity to which it is addressed and may contain confidential and/or privileged material. If you are not the intended recipient of this e-mail, any use, review, retransmission, distribution, dissemination, copying, printing, or other use of, or taking of any action in reliance upon this e-mail, is strictly prohibited. If you have received this e-mail in error, please contact the sender and delete the original and any copy of this e-mail and any printout thereof, immediately. Your co-operation is appreciated.

Le présent courriel (y compris toute pièce jointe) s'adresse uniquement à son destinataire, qu'il soit une personne ou un organisme, et pourrait comporter des renseignements privilégiés ou confidentiels. Si vous n'êtes pas le destinataire du courriel, il est interdit d'utiliser, de revoir, de retransmettre, de distribuer, de disséminer, de copier ou d'imprimer ce courriel, d'agir en vous y fiant ou de vous en servir de toute autre façon. Si vous avez reçu le présent courriel par erreur, prière de communiquer avec l'expéditeur et d'éliminer l'original du courriel, ainsi que toute copie électronique ou imprimée de celui-ci, immédiatement. Nous sommes reconnaissants de votre collaboration.

## Sabo,Ashley (IAAC/AEIC)

---

**From:** Gauthier, Rick <RGauthier@nbpower.com>  
**Sent:** September 29, 2022 11:30 AM  
**To:** Vigder,Joseph (IAAC/AEIC)  
**Cc:** Harris, Claire; Hayward, Andy; Woodworth, Wayne  
**Subject:** RE: EXT - Potential Federal Financial Assistance - ARC SMR Project

**Categories:** For ATIP

Joe, I have requested the details of the potential federal assistance and will forward to you as soon as I receive the response. With the long weekend I expect it early next week.



Rick Gauthier  
*Licensing Manager*  
*Advanced Reactor Development Team*  
506.651.3286  
nbpower.com | energienb.com

**From:** Vigder,Joseph (IAAC/AEIC) <joseph.vigder@iaac-aeic.gc.ca>  
**Sent:** September 29, 2022 11:49 AM  
**To:** Gauthier, Rick <RGauthier@nbpower.com>  
**Cc:** Harris, Claire <CHarris@nbpower.com>; Hayward, Andy <AHayward@nbpower.com>  
**Subject:** EXT - Potential Federal Financial Assistance - ARC SMR Project

\*\*\* Attention: External Message / Message externe \*\*\*

Hi Rick,

Thank you for sending the picture of the potential future site of the Moltex facility yesterday.

I had another unrelated question regarding potential federal financial assistance for the proposed ARC SMR commercial demonstration unit. The information you submitted on September 2 indicates that NB Power is seeking federal assistance through the Clean Electricity Fund. I am wondering who exactly NB Power has been in discussions with regarding this potential funding.

Similarly, the information notes that NB Power may seek funding from the CIB. If you have a specific contact at the CIB with whom you have been having initial discussions, it would be appreciated if you could share with us so we can reach out, as necessary.

For some general context, as you may know, issuance of federal funding may have implications on the Minister's ability to designate a project and on the scope of effects that may be considered in a potential assessment.

Happy to chat if you have any questions or want any more context.

Thank you,

Joe Vigder  
(he/him | il)

Project Manager, Atlantic Region  
Impact Assessment Agency of Canada / Government of Canada  
[joseph.vigder@iaac-aeic.gc.ca](mailto:joseph.vigder@iaac-aeic.gc.ca) / Tel : 902-229-9637

Gestionnaire de projets, région atlantique  
Agence d'évaluation d'impact du Canada / Gouvernement du Canada  
[joseph.vigder@iaac-aeic.gc.ca](mailto:joseph.vigder@iaac-aeic.gc.ca) / Tél : 902-229-9637



---

This e-mail communication (including any or all attachments) is intended only for the use of the person or entity to which it is addressed and may contain confidential and/or privileged material. If you are not the intended recipient of this e-mail, any use, review, retransmission, distribution, dissemination, copying, printing, or other use of, or taking of any action in reliance upon this e-mail, is strictly prohibited. If you have received this e-mail in error, please contact the sender and delete the original and any copy of this e-mail and any printout thereof, immediately. Your co-operation is appreciated.

Le présent courriel (y compris toute pièce jointe) s'adresse uniquement à son destinataire, qu'il soit une personne ou un organisme, et pourrait comporter des renseignements privilégiés ou confidentiels. Si vous n'êtes pas le destinataire du courriel, il est interdit d'utiliser, de revoir, de retransmettre, de distribuer, de disséminer, de copier ou d'imprimer ce courriel, d'agir en vous y fiant ou de vous en servir de toute autre façon. Si vous avez reçu le présent courriel par erreur, prière de communiquer avec l'expéditeur et d'éliminer l'original du courriel, ainsi que toute copie électronique ou imprimée de celui-ci, immédiatement. Nous sommes reconnaissants de votre collaboration.



## Sabo,Ashley (IAAC/AEIC)

---

**From:** Kwamena, Nana-Owusua <Nana-Owusua.Kwamena@cnscccsn.gc.ca>  
**Sent:** October 5, 2022 5:43 PM  
**To:** Spagnuolo,Colette (IAAC/AEIC); Harpell, Heather  
**Cc:** Virtue,Robyn-Lynne (IAAC/AEIC)  
**Subject:** RE: Posting Complete - Designation Request - Small Modular Reactor Demonstration Project (Oct 4)

Hello Colette,

Thanks for passing this information along. Appreciate being kept in the loop and understanding where the process is going.

There is one small point I would like to raise: I would like to ensure that CNSC's Environmental Assessment Division is being included as part of the distribution list for key correspondence to ensure that we also receive this information first hand along with our licensing lead.

Heather has also reached out to Joe Vigder to inform him that she will be responding on behalf of the CNSC with respect to the request for information. Therefore, we have passed along this similar messaging to the Region to ensure Heather is kept informed of any next steps or key information.

Please let us know if you need anything else from us.

Thanks again for passing along these updates.  
Nana

*Nana Kwamena* (she, her, elle)  
Director, EAD | Directrice, DEE  
[nana-owusua.kwamena@cnscccsn.gc.ca](mailto:nana-owusua.kwamena@cnscccsn.gc.ca) | Tel: 343-543-6760

**From:** Spagnuolo,Colette (IAAC/AEIC) <Colette.Spagnuolo@iaac-aeic.gc.ca>  
**Sent:** Wednesday, October 5, 2022 1:59 PM  
**To:** Harpell, Heather <Heather.Harpell@cnscccsn.gc.ca>; Kwamena, Nana-Owusua <Nana-Owusua.Kwamena@cnscccsn.gc.ca>  
**Cc:** Virtue,Robyn-Lynne (IAAC/AEIC) <Robyn-Lynne.Virtue@iaac-aeic.gc.ca>  
**Subject:** FW: Posting Complete - Designation Request - Small Modular Reactor Demonstration Project (Oct 4)

---

EXTERNAL EMAIL – USE CAUTION / COURRIEL EXTERNE – FAITES PREUVE DE PRUDENCE

---

UNCLASSIFIED - NON CLASSIFIÉ

Hello Nana and Heather,

Just flagging that the Agency commenced the designation request process for the NB Power ARC-100 project earlier this week. The public notices, as well as the letters to the requestor and to NB Power, are attached for ease of reference.

Apologies if you received this information through other sources, but wanted to make sure you were in the loop. The CNSC licensing lead was cc'd on the letters.

Thanks,  
Colette

**From:** Lu,Curtis (IAAC/AEIC) <[Curtis.Lu@iaac-aeic.gc.ca](mailto:Curtis.Lu@iaac-aeic.gc.ca)>

**Sent:** Tuesday, October 4, 2022 11:04 AM

**To:** Walters,Christopher (IAAC/AEIC) <[Christopher.Walters@iaac-aeic.gc.ca](mailto:Christopher.Walters@iaac-aeic.gc.ca)>; Hubbard,Terence (IAAC/AEIC) <[Terence.Hubbard@iaac-aeic.gc.ca](mailto:Terence.Hubbard@iaac-aeic.gc.ca)>; Chapman,Steve (IAAC/AEIC) <[Steve.Chapman@iaac-aeic.gc.ca](mailto:Steve.Chapman@iaac-aeic.gc.ca)>; Spagnuolo,Colette (IAAC/AEIC) <[Colette.Spagnuolo@iaac-aeic.gc.ca](mailto:Colette.Spagnuolo@iaac-aeic.gc.ca)>; Landry,Eric (IAAC/AEIC) <[eric.landry@iaac-aeic.gc.ca](mailto:eric.landry@iaac-aeic.gc.ca)>; Seeto,Philip (IAAC/AEIC) <[Philip.Seeto@iaac-aeic.gc.ca](mailto:Philip.Seeto@iaac-aeic.gc.ca)>; Croteau,Jean-Philippe (IAAC/AEIC) <[Jean-Philippe.Croteau@iaac-aeic.gc.ca](mailto:Jean-Philippe.Croteau@iaac-aeic.gc.ca)>; Ketcheson,Ian (IAAC/AEIC) <[Ian.Ketcheson@iaac-aeic.gc.ca](mailto:Ian.Ketcheson@iaac-aeic.gc.ca)>; Brady,Patricia (IAAC/AEIC) <[patricia.brady@iaac-aeic.gc.ca](mailto:patricia.brady@iaac-aeic.gc.ca)>; Carriere,Sean (IAAC/AEIC) <[Sean.Carriere@iaac-aeic.gc.ca](mailto:Sean.Carriere@iaac-aeic.gc.ca)>

**Cc:** Fish,Karen (IAAC/AEIC) <[Karen.Fish@iaac-aeic.gc.ca](mailto:Karen.Fish@iaac-aeic.gc.ca)>; Moore,Wesley (IAAC/AEIC) <[Wesley.Moore@iaac-aeic.gc.ca](mailto:Wesley.Moore@iaac-aeic.gc.ca)>; Mailloux,Julie (IAAC/AEIC) <[Julie.Mailloux@iaac-aeic.gc.ca](mailto:Julie.Mailloux@iaac-aeic.gc.ca)>; Keen,Alison (IAAC/AEIC) <[alison.keen@iaac-aeic.gc.ca](mailto:alison.keen@iaac-aeic.gc.ca)>; Boucher Lalonde,Veronique (IAAC/AEIC) <[Veronique.BoucherLalonde@iaac-aeic.gc.ca](mailto:Veronique.BoucherLalonde@iaac-aeic.gc.ca)>; Macdonald,Nancy (IAAC/AEIC) <[Nancy.Macdonald@iaac-aeic.gc.ca](mailto:Nancy.Macdonald@iaac-aeic.gc.ca)>; Blair,Kevin (IAAC/AEIC) <[Kevin.Blair@iaac-aeic.gc.ca](mailto:Kevin.Blair@iaac-aeic.gc.ca)>; Kubesh,Mary (IAAC/AEIC) <[Mary.Kubesh@iaac-aeic.gc.ca](mailto:Mary.Kubesh@iaac-aeic.gc.ca)>

**Subject:** Posting Complete - Designation Request - Small Modular Reactor Demonstration Project (Oct 4)

Hello,

The Agency posted today at **11 a.m. EDT** the designation request for the Small Modular Reactor Demonstration Project in New Brunswick.

The posting consisted of the project page and request being posted to the Agency's Registry site. No news release or public notice was issued

For more info:

**Small Modular Reactor Demonstration Project**

EN: <http://iaac-aeic.gc.ca/050/evaluations/proj/83998?culture=en-CA>

FR: <http://iaac-aeic.gc.ca/050/evaluations/proj/83998?culture=fr-CA>

**Request for Designation of Project**

EN: <http://iaac-aeic.gc.ca/050/evaluations/document/145163?culture=en-CA>

FR: <http://iaac-aeic.gc.ca/050/evaluations/document/145163?culture=fr-CA>

**Curtis Lu**

Impact Assessment Agency of Canada | Agence d'évaluation d'impact du Canada

160 Elgin St, 22nd Floor, Ottawa, ON K1A 0H3 | 160, rue Elgin, 22e étage, Ottawa (Ontario) K1A 0H3

[iaac.information.aeic.gc.ca](http://iaac.information.aeic.gc.ca) | 613-957-0700 | 1-866-582-1884



Government  
of Canada

Gouvernement  
du Canada

## Appendix B: ARC Clean Energy Presentation

**Transcript and slide excerpts from the presentation: "The ARC-100 Advanced SMR" by ARC Clean Energy on February 22, 2021.**

Presented to the National Academies of Sciences, Engineering, and Medicine, Expert Committee on the Merits and Viability of Different Nuclear Fuel Cycles and Technology Options and the Waste Aspects of Advanced Nuclear Reactors, Washington, D.C.

Link to meeting information and webcast archive of Day 1 of meeting:

<https://www.nationalacademies.org/event/02-22-2021/merits-and-viability-of-different-nuclear-fuel-cycles-and-technology-options-and-the-waste-aspects-of-advanced-nuclear-reactors-february-22-and-23-2021-meeting>

**ARC Clean Energy presentation begins at 3:42:45 of the meeting archive.**



(Session chair speaking)

For our next session, we have representatives from ARC Clean Energy. We have with us, Dr. Ed Arthur, who was Vice President for fuel cycle management and safeguards. He retired from the Los Alamos National Laboratory in 2003 after a 30-year technical management career. He was involved in a wide range of nuclear technologies and applications. He's done a number of consulting for our national laboratories at Sandia, Argonne and Idaho. And he's also been involved in establishing a center for nonproliferation at the University of New Mexico. Dr. Arthur has a PhD in nuclear physics from the University of Virginia. And with him is Dr. John Sackett, who is the Senior Vice President and Chief Technology Officer at ARC. He joined the Advanced Reactor Concepts, ARC, in 2006. His entire career has been related to research in sodium fast cooled fast reactors, having worked at Argonne National Laboratory for 34 years. Dr. Sackett has a PhD in Nuclear Engineering from the University of Arizona. So welcome to our guest speakers, you may begin please.

**Resource Utilization**

- The ARC-100 Integrates smoothly into the existing uranium infrastructure
- The ARC-100 can operate in a once-through or recycle fuel cycle
- The ARC-100 can use fissile materials from existing used fuel stockpiles, thus extending the uranium resource (decreases uranium mining, conversion, enrichment requirements)
- Its use of HALEU requires changes in enrichment facilities (>5% U235) or down blending of HEU
- The ARC-100 reactor and recycle system can be sustained indefinitely if recycling is used

10

ARC  
CLEAN ENERGY

Ed Arthur speaking

(Ed Arthur speaking)

Let me mention that the ultimate fuel cycle and vision for the ARC System of reactions is recycled used fuel via use of pyroprocessing separations technology.

The ARC-100 operates within the uranium plutonium fuel cycle as shown. As John described earlier the ARC core consists of several zones, U-235 enrichment is 10% or greater, but much less than 20%. And, obviously, the availability of HALEU is a major requirement, as is the case for many of the reactor designs presented to the committee.

The requirement of HALEU obviously means enrichment facilities that must exist that can extract, that could produce greater than 5% enriched material or the fact that as a source of downloaded or blended of HE would also be another pathway for HALEU.

As I mentioned earlier, the long-term goal for the ARC system is recycled used fuel in a closed fuel cycle system. Doing this would decrease the role of fuel cycle components associated with mining conversion enrichment and thereby eliminating large sources of nuclear waste from the current fuel cycle.

And finally, if recycling is used, then the ARC reactor system can be sustained indefinitely.

\*\*\*

### ARC-100 Fuel Cycle Assumptions

- An open cycle is the currently planned approach
- The used fuel, after the 20-year cycle is over, would be stored within the facility to allow cooling, after which the fuel would be sodium washed and then be transferred to on-site dry storage

20-year fuel discharged isotopics)

For a core with 24 tons of HM and 3.2 tons of U235

U234	.001 MT
U235	1.6 MT
U236	.3 MT
U238	19.3 MT
Pu238	.004 MT
Pu239	1.03 MT
Pu240	.07 MT
Pu241	.003 MT
MA	.026 MT

11

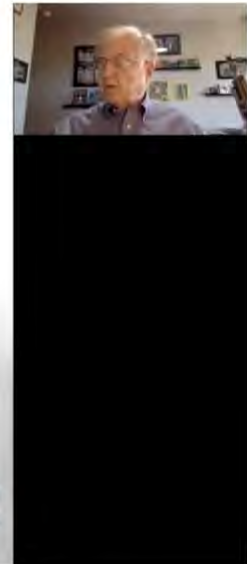

(Ed Arthur speaking)

Fuels cycle assumptions. Open cycle is the currently planned approach until technical and political environments become more favorable for recycle.

The used fuel recovered after being in the reactor for 20 years would be removed, stored within the facilities to allow cooling, after which the fuel would be sodium washed and then transferred to onsite storage. With each fuel discharge, fresh fuel would be introduced into the reactor, the process would occur at the year 20, 40 and 60 years with 60 years being the presumed lifetime of the facility.

Of course, during the 40-to-60-year period, recycle could begin thus changing the storage and disposal requirements of the ARC fuel cycle. I show a table on here, which indicates uranium and TRU isotope inventory is discharged after 20 years after an initial fuel loading of 24 tons of HALEU metal containing 3.2 tons of U-235.

The thing to note is in-growth of plutonium-239 in addition to the U-235 that will exist in the discharged used fuel. This means after 20 years of discharge materials has as much fissile quantity of material capability as fresh fuel.

\*\*\*

### The Preferred Long-Term ARC-100 Fuel Cycle – Recover TRU and Use in New Fuel For Reconditioned ARC

- The ARC-100 fuel, after 20-year operation, contains as much fissile content (Pu, U235) as BOL (U235 only)
- Pyroprocessing would be used to recover TRU for fabrication into fresh fuel
- Metal fuel feed eliminates need for oxide reduction  
LWR oxide fuel also a potential feed for pyroprocessing
- 20-year fuel irradiation provides ample time (> 30 years) for a deliberate planning and development program

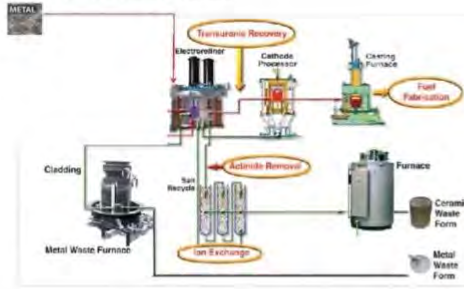

12

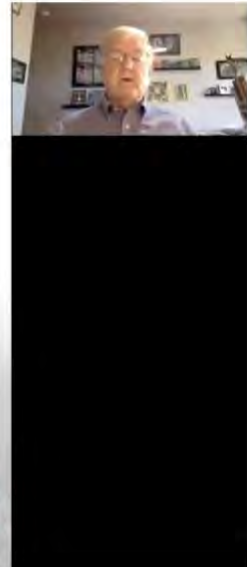

(Ed Arthur speaking)

As I mentioned before, the preferred long-term approach for the ARC-100 is recovered TRU and use new fuel in a reconditioned ARC. As I just mentioned, after 20 years of operation, the fuel contains as much fissile material as at the beginning of life.

Pyroprocessing will be used to recover TRU for fabrication into a fresh fuel using the top-level flow sheet illustrated just to the right of the right portion of the chart. And the metal fuel, of course, eliminates the need for oxide reduction. So, the material would go into an electro-refiner, and go from there into the pyroprocessing facility. Oxide fuel would be used but it would require an additional step of oxide reduction to metal in the type of flow sheet.

I'd like to note that the 20-year fuel irradiation of the ARC-100 provides ample time, perhaps greater than 20, 30 years for a deliberate planning and development program for recycle. And I'll come back to that point later.

\*\*\*



## ARC Pyroprocessing Technology Status

- EBR-II fuel was processed and recycled to the reactor in the 1960s
- Pyroprocessing technology was developed at EBR-II in the 1980s and was proposed for used EBR-II fuel treatment following the shutdown of EBR-II
- A NAS committee charged with following its development found no technical barriers with the electrometallurgical technology for EBR-II fuel treatment
- Pyroprocessing of EBR-II continues today at the INL
- Major equipment components have been scaled to pre-pilot scale (multiple kgs)



ARC  
CLEAN ENERGY

13



(Ed Arthur speaking)

Let's take a look at the pyroprocessing technology status. The EBR-II fuel was processed and recycled to the reactor in the 1990s mainly by melt refining. Later, pyroprocessing technologies were developed at EBR-II in the 80s and also proposed for treatment after the shutdown of the EBR-II.

At the time, the National Academy committee reviewed Argonne's plan and the technology that was going to be used and found no technical barriers with that technology for EBR fuel treatment. So, the pyroprocessing of EBR-II fuel continues today at the Idaho National Laboratory. And along the way of course major components have been scaled up to pre-pilot level scale, and the picture shows an electro-refiner of that type.

\*\*\*



## A 100 MT HM Facility Is Appropriate for Planning

- A beginning preconceptual design exists for a 100 MT facility (Chang, *Nuclear Technology* 2018)
- The design lays out major components and unit processing steps
- The preconceptual design report also includes facilities for security, waste management
- Material forms, flows, safety, safeguards assessment performed
- Salt waste generation has been estimated (Simpson 2011)
  - 15-20 MT/yr (ER salt, Na removed)
  - glass holding 10% salt waste - -140 MT
  - salt waste disposal in a salt repository -- 7 m<sup>3</sup>/yr for a 100 MT HM facility



ARC  
CLEAN ENERGY

14

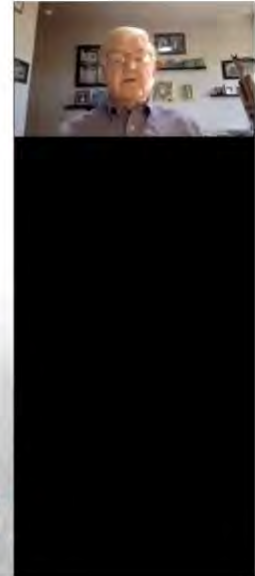

(Ed Arthur speaking)

So, it's not too early in the process, to start looking, taking a systems look at what would be involved in recovering TRU and so on from ARC fuels. So, what we've done is we've looked at a pre-conceptual design, a 100 metric ton pre-conceptual design facility that was done by Argonne and Sandia and published.

The design lays out major components and processing steps. It also has facilities for security waste management. And also, Sandia did a very nice safeguards assessment of the facility. The reason I bring it up today is one can start, in a systems way, looking at what comes out of the back end in terms of waste.

The salt generation has been estimated by Mike Simpson, he was an electrochemist at Argonne, he is now at the University of Utah. He estimated in the paper in 2011, that for a 100 metric ton heavy metal facility, about 15 to 20 metric tons per year of electro-refiner salt would come out. .. salt is putting in glass at a 10% loading, and then the glass production per year would be 140 metric tons. One could in the future, and Mike suggests this, that the salt waste could be disposed of in a salt repository, such as a whip, and that would be on the order of five to 10 cubic meters of salt waste per year from the facility.

\*\*

### Licensing

- ARC's licensing efforts have focused on the Canadian regulatory system (REGDOC-3.5.4, *Pre-Licensing Review of a Vendor's Reactor Design*) since a design for the New Brunswick Power's Point LePreau site is being pursued. Vendor Design Review 1 (VDR1) successfully completed (2019) and VDR2 is now being pursued.
- The ARC-100 built at the Point LePreau would be a heavily instrumented FOAK

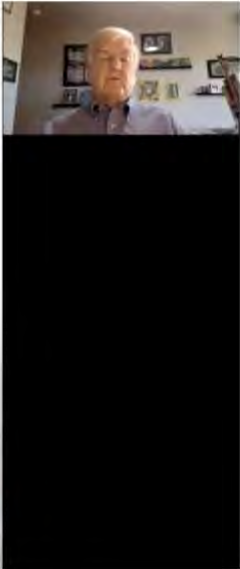
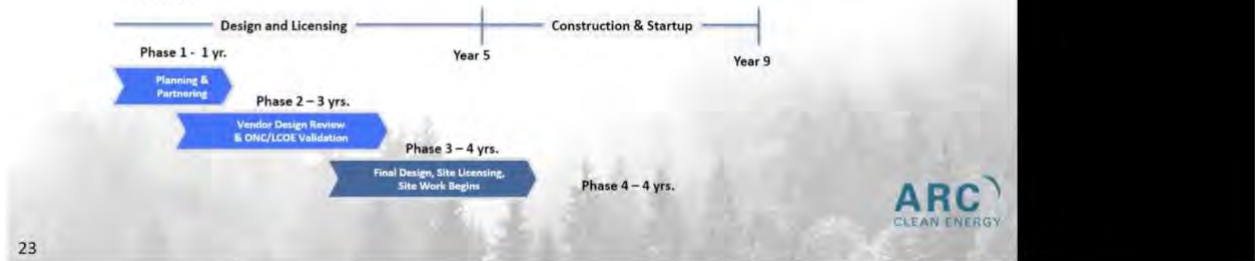

(Ed Arthur speaking)

Licensing. I think John mentioned that one of our focus areas has been development of a first of a kind reactor for the Point Lepreau site in Canada. So, our licensing efforts have focused on the Canadian regulatory system, which is described in the documents that you see listed on the chart.

The process is a series of vendor design reviews. We've completed the first one, and that was in 2019. And the second VDR 2, which is much more extensive, is now being pursued.

We would mention again, I think we have, that the ARC-100 built at Point Lepreau would be a heavily instrumented first of a kind.

We estimate that with the proper funding and regulatory approvals and so on, that we could design and construct and began initial testing and start up within a nine-or-10-year period.

\*\*\*